

# A New Product From Fast Hay Movers Inc., Home of the Hay Baby



## Round Hay Bale Net/Plastic Sleever Guide

Lonnie Fast  
304-282-1210

[lb@fasthaymovers.com](mailto:lb@fasthaymovers.com)

[fasthaymovers.com](http://fasthaymovers.com)



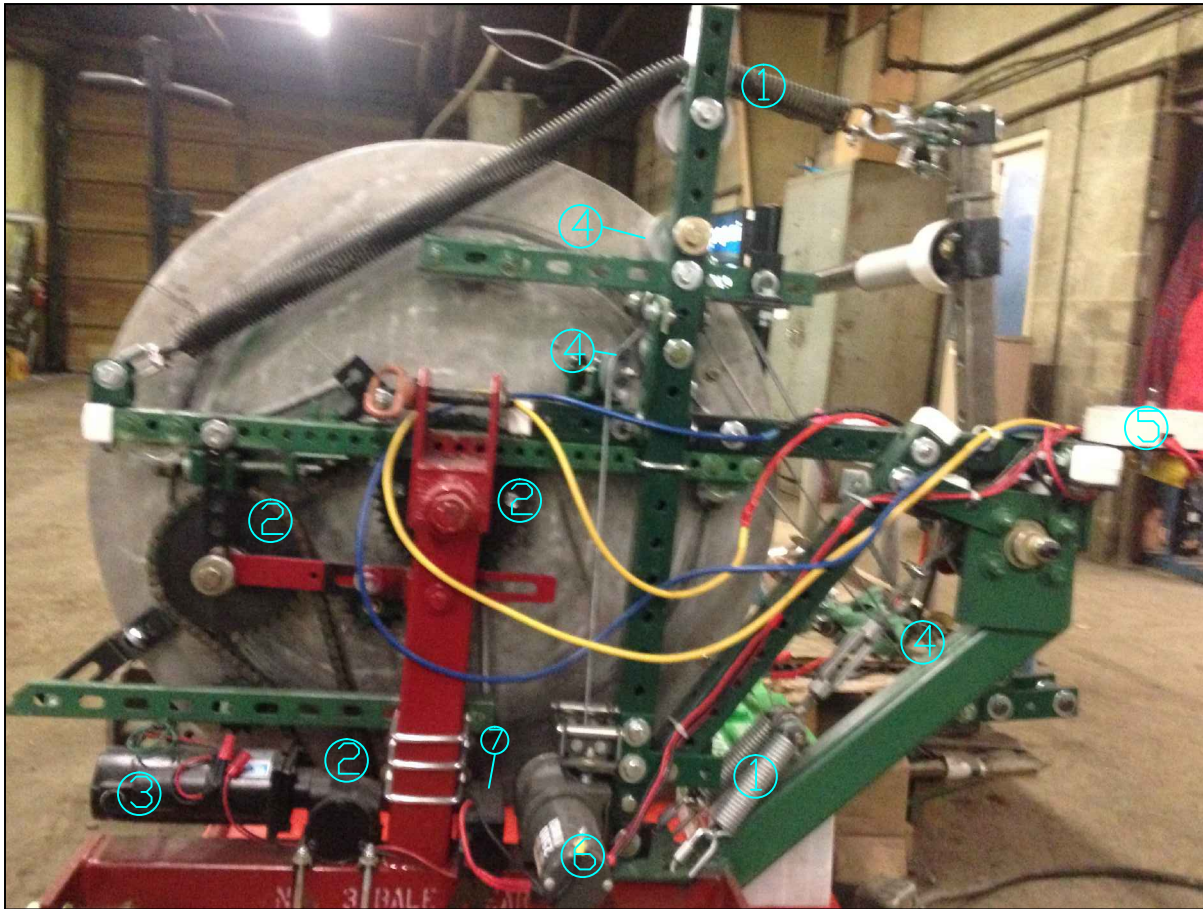

- ① wrap tension spring
- ② chain and sprocket drive
- ③ 12v DC motor
- ④ pulleys to winch
- ⑤ toggle switch for motor
- ⑥ 12v DC winch
- ⑦ relay box for winch

SCALE		 <b>NORTHCO CORP.</b> 14 Monongahela Ave. PO Box 2100 MORGANTOWN, WV 26502		
JOB NUMBER	TITLE	ISSUED	CHECKED	REVISION
		DATE	DATE	DATE
	FOR	DRAWING NUMBER		
	0			
	0			

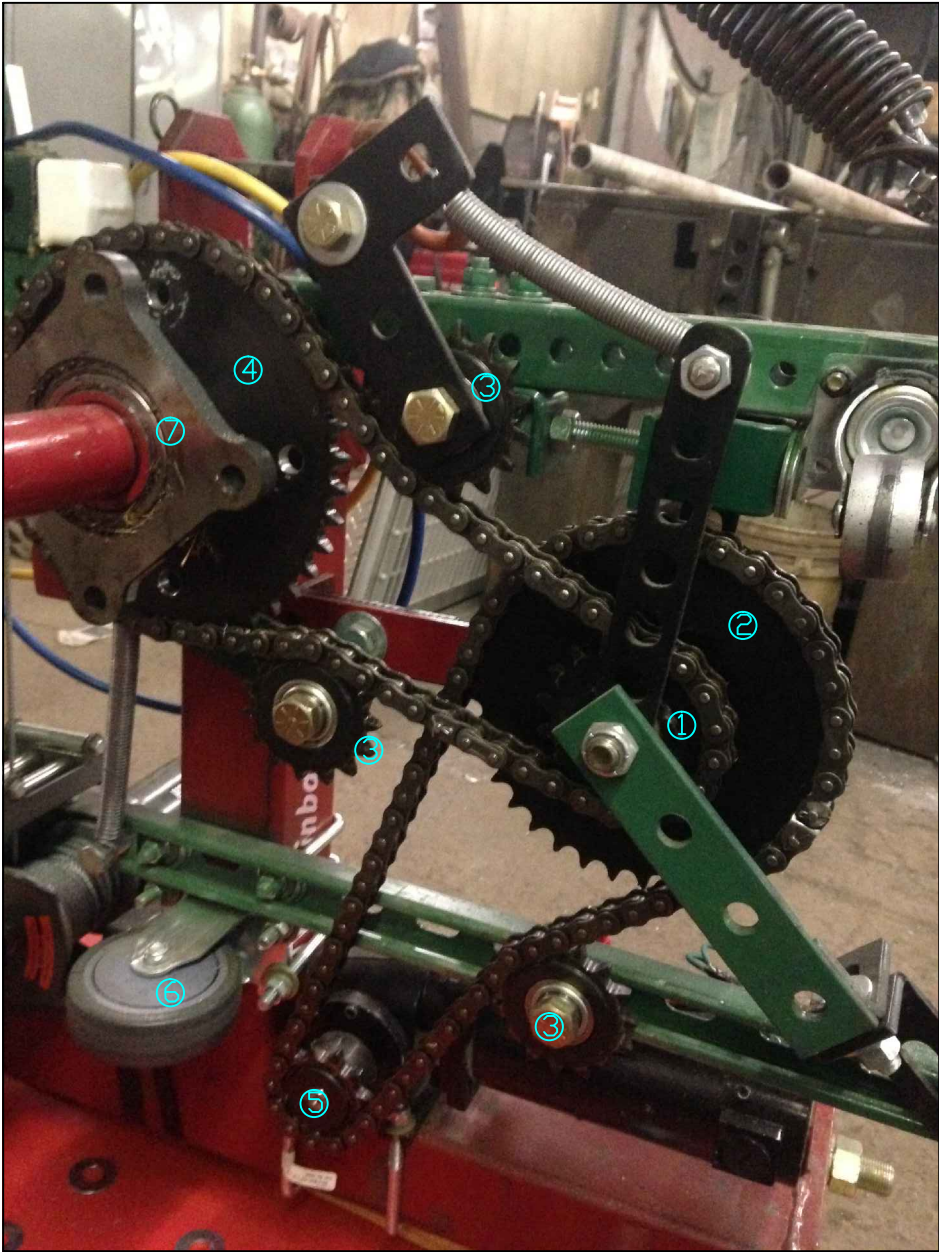

1-2

- ① NO. 50 5/8" pitch 3.7in 17t
- ② NO. 50 5/8" pitch 7.52in 36t
- ③ NO. 50 5/8" pitch 3.3in 15t
- ④ NO. 50 5/8" pitch 8.3in 40t
- ⑤ NO. 50 5/8" pitch 2.7in 12t
- ⑥ support wheel on bottom  
has the most pressure  
so a rubberized wheel is  
recommended
- ⑦ 4 bolt type E  
flange bearing

SCALE	 <b>NORTHCO CORP.</b> 14 Monongahela Ave. PO Box 2100 MORGANTOWN, WV 26502			
JOB NUMBER	TITLE	DATE	DATE	DATE
	PER	DRAWING NUMBER		
	0			
	0			



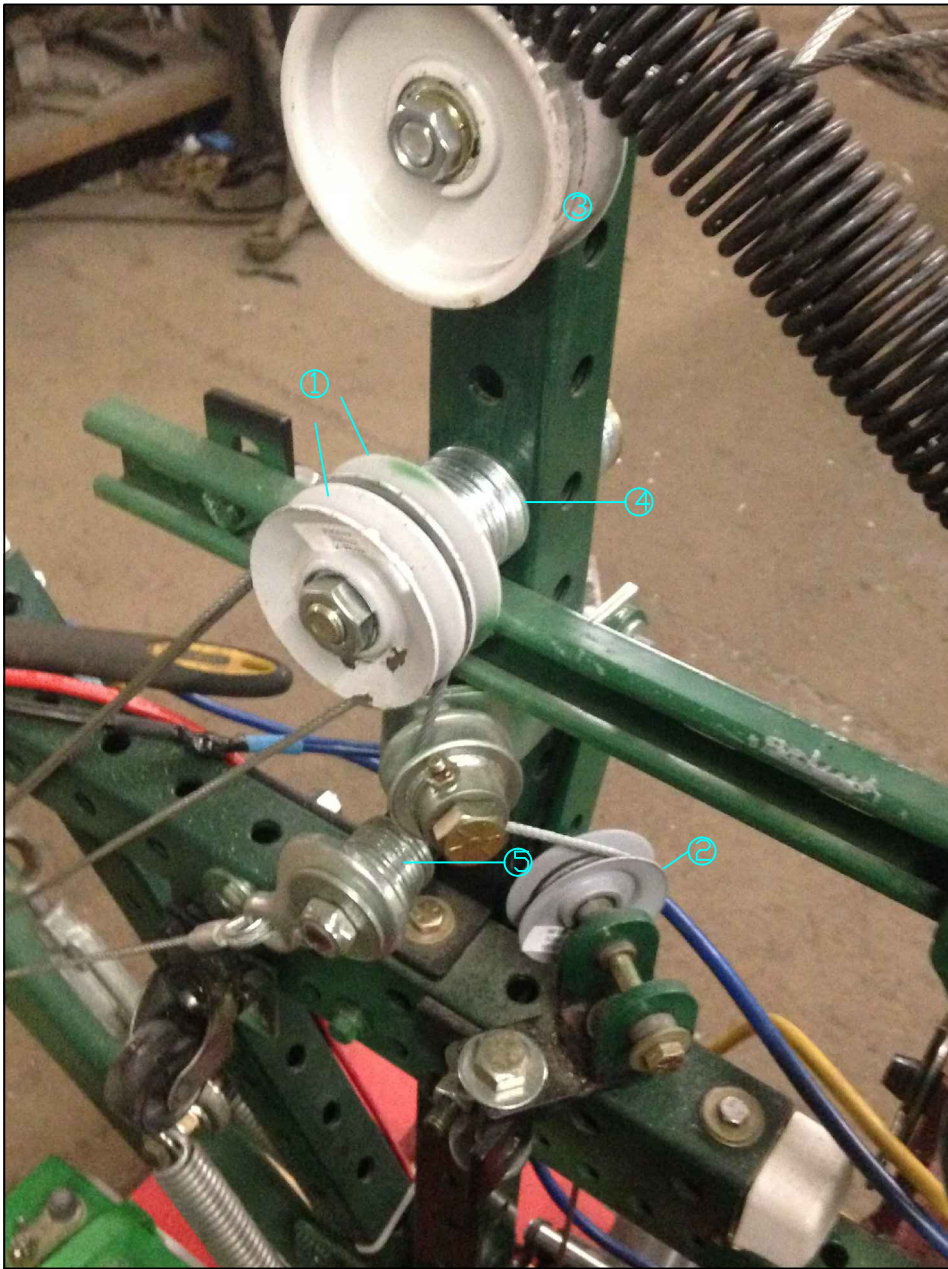

pulley detail 1-3

① PHOENIX 35300050  
VI-300-050

② PHOENIX 352265050  
VI-265-050

③ 3-5/8" guide wheel  
for tension spring

④ 1<sup>9</sup>/<sub>16</sub>" spacer

⑤ 2<sup>3</sup>/<sub>4</sub>" spacer

SCALE	 <b>NORTHCO CORP.</b> 14 Monongahela Ave. PO Box 2100 MORGANTOWN, WV 26502			
JOB NUMBER	TITLE	ISSUED	CHECKED	REVISION
		DATE	DATE	DATE
	FOR	DRAWING NUMBER		
	0			
	0			

wire diagram 1-4

- ① 12V power supply
- ② junction box with toggle switch for reversible motor
- ③ relay box for winch
- ④ power to winch
- ⑤ power to motor

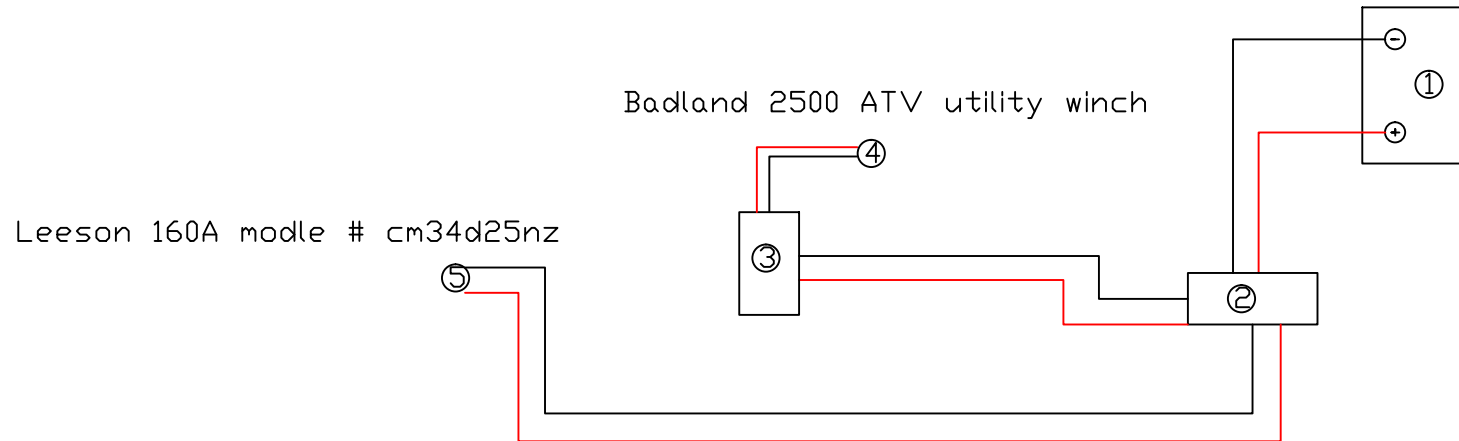

SCALE	 NORTHCO CORP.			
	14 Monongahela Ave. PO Box 2100		MORGANTOWN, WV 26502	
JOB NUMBER	TITLE	ISSUED	CHECKED	REVISION
		DATE	DATE	DATE
	PER 0	DRAWING NUMBER		
	0			



pipe collar welded to sq tubing for adjustable arm  
 6" of solid round in pipe at threads for reinforcement

SCALE	 NORTHCO CORP. 14 Monongahela Ave. PO Box 2100 MORGANTOWN, WV 26502			
JOB NUMBER	TITLE	ISSUED	CHECKED	REVISION
		DATE	DATE	DATE
	FOR	DRAWING NUMBER		
	0			
	0			

winch adjusted tension wrap arm

1-6

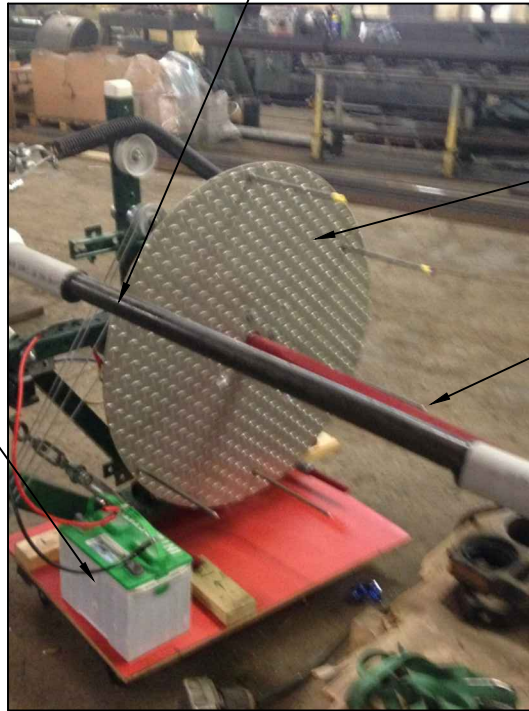

motor driven rotating plate  
36" DIA

bale spear

12v power supply

SCALE	 <b>NORTHCO CORP.</b> 14 Monongahela Ave.    PO Box 2100    MORGANTOWN, WV 26502			
JOB NUMBER	TITLE	ISSUED	CHECKED	REVISION
		DATE	DATE	DATE
	FOR	DRAWING NUMBER		
	0			
	0			

## Materiel list

Leeson model # CM34D25NZ 160A motor

Badland ATV utility winch

Number 3 bale spear

rear wheel bearing

garage door spring

(2) porch swing springs

(2) Hillman #58 springs

DP DT toggle switch NSI 4DP 20A 1/2

8' p9200 unistrut

3' p9000 unistrut

(3) P 1973 u bracket

(7) P 1750 small angle bracket

(4) P 1498 large angle bracket

(2) P 1380A small L bracket

(3) P 1036 L bracket

(2) P 2324 flat braket 3 holes

(2) P 1067 flat bracket 4 holes

(3) NO. 50 5/8" pitch 3.3in 15t

NO. 50 5/8" pitch 3.7in 17t

NO. 50 5/8" pitch 7.52in 36t

NO. 50 5/8" pitch 8.3in 40t

NO. 50 5/8" pitch 2.7in 12t

1 $\frac{9}{16}$ " spacer2 $\frac{3}{4}$ " spacer

(2)PHOENIX 35300050 VI-300-050

PHOENIX 352265050 VI-265-050

3-5/8" guide wheel for tension spring

4 bolt type E flange bearing

36" aluminum deck plate drilled to match flange bearing

12V power supply / battery

(3) 3/8" 3"X4" u bolts

60" sch 80 pipe threaded pipe cap and collar

4 support wheels for rotating plate







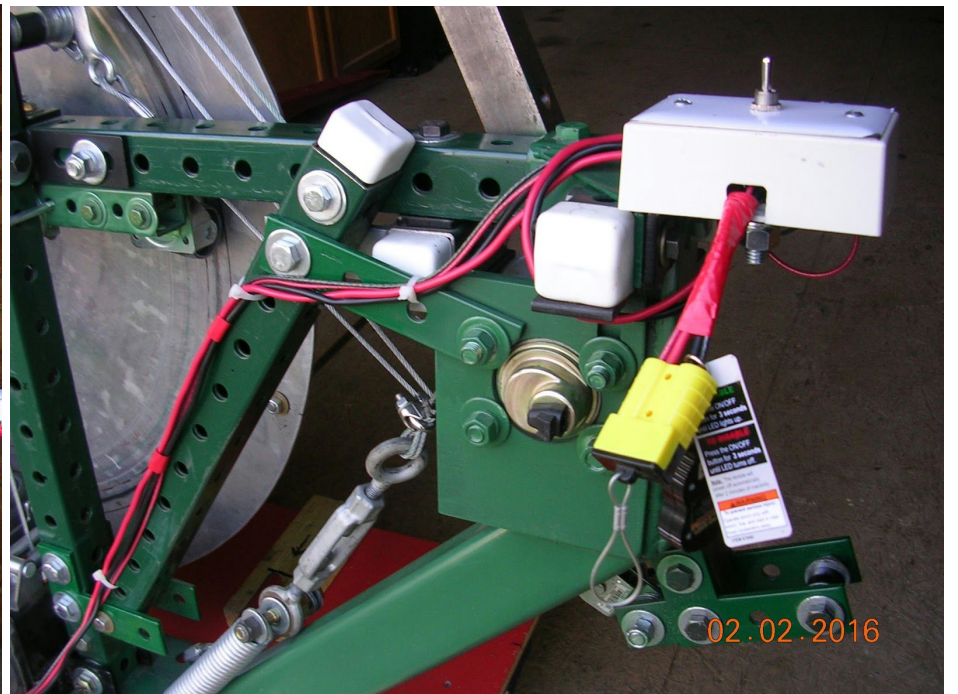
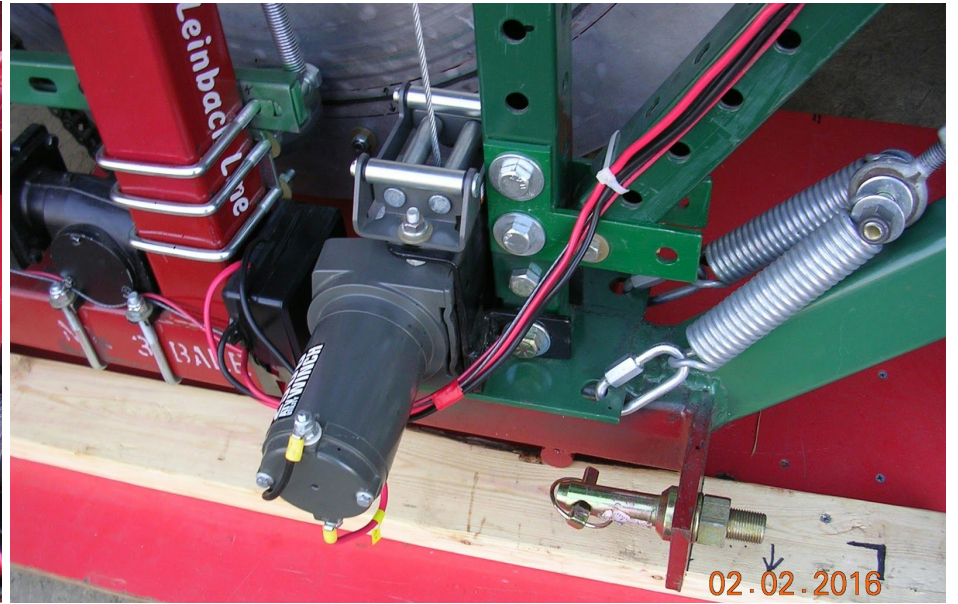





02.05.2016