

The Rocket

Sap Evaporator

2

1

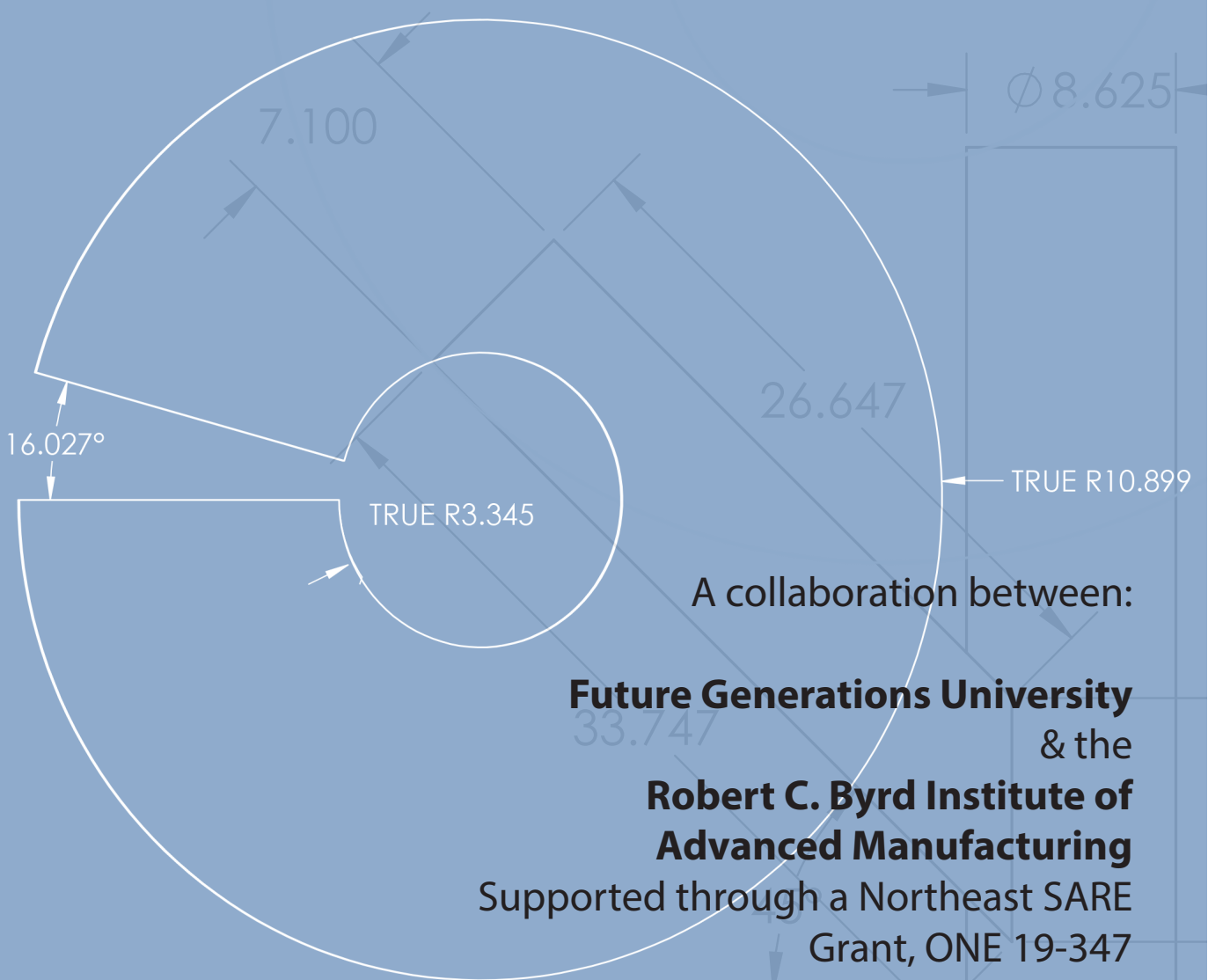



At the controls,
Commanders:
Mike Rechlin, FGU, and
Arley Carpenter, RCBI

Blast Off with the Rocket Sap Evaporator.

The Rocket sap evaporator is a stove designed to provide a fast and vigorous boil with near complete combustion resulting in efficient wood use. Based on rocket stove principles, this sap evaporator was also designed to be inexpensive to build and capable of being fabricated by a local welder. The Rocket sap evaporator is meant for “backyard” syrup producers. If you have up to 20 maple trees or 30 walnut trees in your backyard or neighborhood, and some friends or family members who like to hang out and feed a fire, you can make all the syrup you’ll need for the year. Developed by West Virginia’s Future Generations University (FGU) in collaboration with the Robert C. Byrd Institute of Advanced Manufacturing (RCBI), these plans and instructions will get you “on the launch pad” and ready for the delicious and fun activity of making maple syrup. So, as they say at NASA.

Systems ready? Roger mission control. 5,4,3,2,1

5. Rocket Stove Principles The basic principle behind a rocket stove incorporates an insulated chimney above a firebox in which wood gasses are ignited providing a fast, energy efficient burn. Properly designed and constructed rocket stoves do not smoke because the wood gasses are burned in the chimney. Unlike most home heating wood stoves, where the fire is dampened down restricting the air flow to achieve a long burn with unburned gasses (smoke) drawn up through the chimney, rocket stoves are burned hot and fast. The advantage of putting a chimney above the fire to achieve complete combustion was discovered in 1780 by Aime Argand and first used in his patented Argand lamp. The complete combustion that resulted provided 6-10 candelas more of light than a standard wicked oil lamp. Its brightness led to the Argand lamp being used in early North American lighthouses.

In the 1980’s Dr. Larry Winiarski, director of the Aprovecho Research Center in Oregon, began engineering stoves for use in developing countries that would maximize energy efficiency, minimize the adverse health effects of a smokey kitchen, and maximize heat transfer to the pot. Energy efficient wood cook stoves are seen as one way of decreasing deforestation. In 2018 our team began working with colleagues at Virginia Tech to test the efficiencies of various backyard sap evaporators. One of the stoves we looked at was an Aprovecho designed rocket stove. We realized that a drawback of the Aprovecho design as a cook stove was an advantage when applied to the evaporation of sap. When cooking food, you seldom want to have the heat as hot as possible, when evaporating sap, you always do.

This Rocket Sap Evaporator is built on Dr. Winiarski’s engineering, as presented in the publication *Design Principles for Wood Burning Cook Stoves*, by the Aprovecho Research Center. Calculated chimney height and gap clearances are all related to chimney diameter and designed to maximize air flow through the stove and heat transfer to the pan. In this document we provide the results of those calculations for 6-inch and 8-inch diameter chimneys. At the Future Generations University website, we provide an interactive excel sheet where you can calculate those variables for any diameter chimney or size barrel.

The goal of the FGU/RCBI collaboration is to not only design an energy efficient stove with a rapid boil, but also the come up with a stove that could easily be fabricated with readily available materials. That work is continuing. For the stove described here, all you need is a 55-gallon drum, a length of 5 or 6-inch diameter pipe, some scrap steel plate, rock wool insulation, and someone who knows how to weld and use a cutting torch. The only component of this evaporator that won't be found in any metal scrap yard worth its salt, or within the ability of someone with a welding torch, is the stainless-steel sap pan. Maple syrup is a food product and it should be cooked in material deemed food safe. You will need to purchase or find someone with the skills and equipment to weld you up a stainless-steel sap pan.

4. The Combustion Chimney The guts of a rocket stove are a firebox and an insulated chimney. Figure 1 shows the combustion chimney in our rocket sap evaporator. This is a piece of 6-inch inside diameter (ID) pipe with a circular wood feed tube welded onto the side. Cutting and piecing two round objects, or a round and a square object together at a 45-degree angle can be a challenging geometry problem. The CADD drawings appended to this document provides measurements that will help. Figure 2 shows another combustion chimney, this time it's an 8-inch ID pipe with a square wood feed. Figure 2 also shows the chimney insulated with rockwool and positioned in a 55-gallon drum. On these stoves we used commercially available rockwool pipe insulation. Rockwool insulation bats wired to the chimney, which can be ordered through most any hardware store, would work just as well.

In figure 2 we have a long wood feed shoot which made it necessary to cut open the barrel to drop in the stove. This had to be sealed off later with aluminum flashing and pop rivets. In figure 1 we have only a short sleeve to the wood shoot which will allow it to be dropped into the barrel without cutting the side. The sleeve will then have a wood shoot extender as a second piece cut precisely through the barrel wall. The wood feed extender on this stove will be made of 6-inch black stove pipe with the crimped top edge inserted into the sleeve. This will minimize the patching needed in the figure 2 stove.



Figure 1 – The chimney and wood feed



Figure 2 – Insulated Chimney

3. Energy Efficiency Step 4 (previous) made a functioning rocket stove. Now we're going to use some engineering to make it energy efficient and maximize heat transfer to the pan. The Winiarski equations provided in Design Principles for Wood Burning Cook Stove provide the height and gap dimensions called for in figures 3,4, and 5. These dimensions are critical to making an efficient stove. The Aprovecho stove has a chimney height that is approximately 3 times the diameter of the firebox, where the cross-sectional area of the chimney is the same as the wood and air feed, and the Gaps, A between the top of the chimney and the bottom of the pot, B between the bottom outer edge of the pot and the flame spreader (which we refer to as the donut) and C between the edge of the donut and the side of the barrel are such that it does not restrict air flow and cause the hot gasses scrape along the bottom of the pan for maximum heat transfer.

**Rocket Sap Evaporator Plans
(First Draft)**

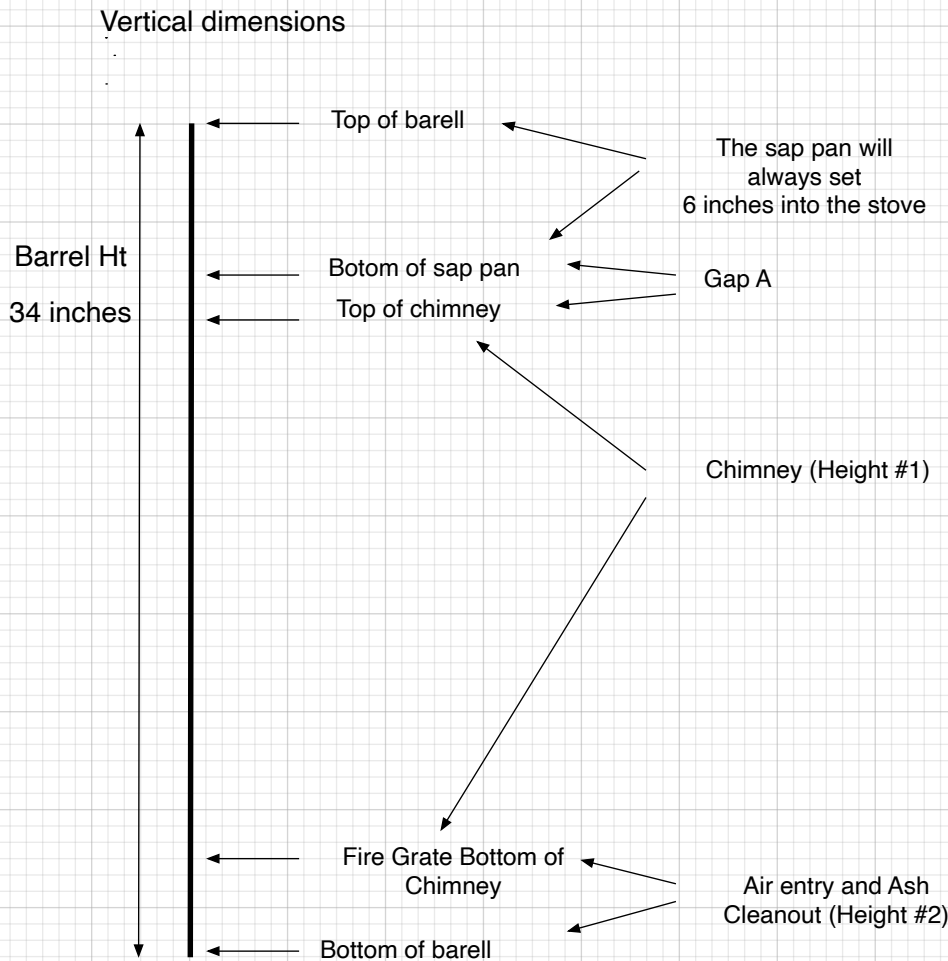
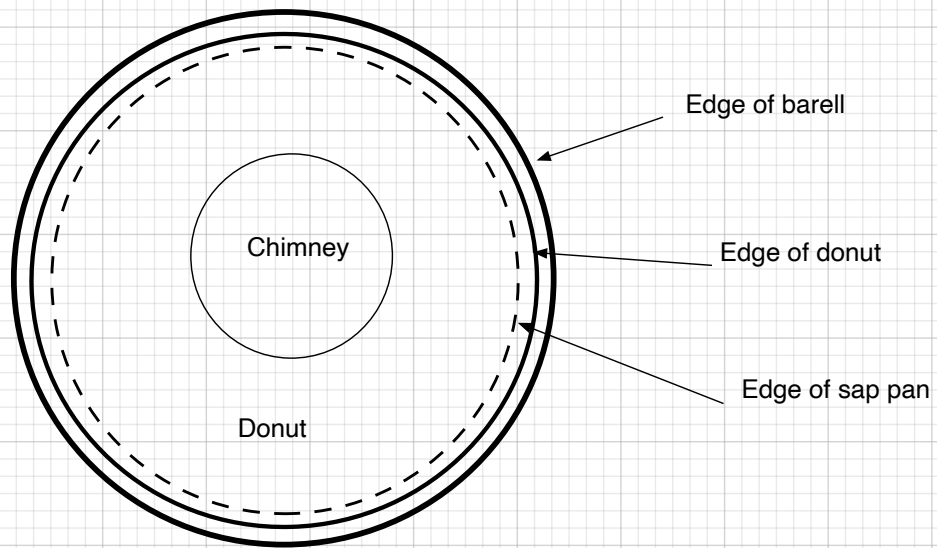
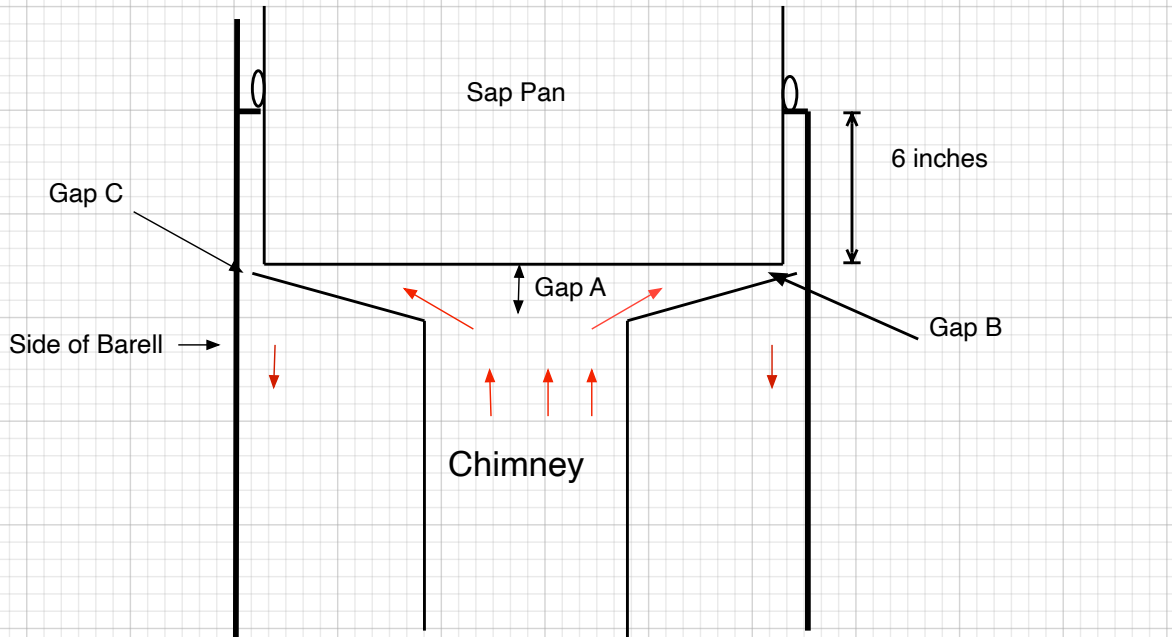

Figure 3 – Vertical dimensions

Notes:

1. $\text{Pan depth} + \text{Ht\#1} + \text{Ht\#2} + \text{Gap A} = 34 \text{ inches (the height of a 55 gallon drum)}$
2. Ht#1, Ht#2, and Gap A are dependent on chimney diameter, calculated on the accompanying interactive spreadsheet

Rocket Evaporator Top



- Gap B - Top pf chimney to bottom of sap pan
- Gap C - Top of donut to bottom of sap pan
- Gap D - Side of barell to edge of donut

Figure 4 – Stove top

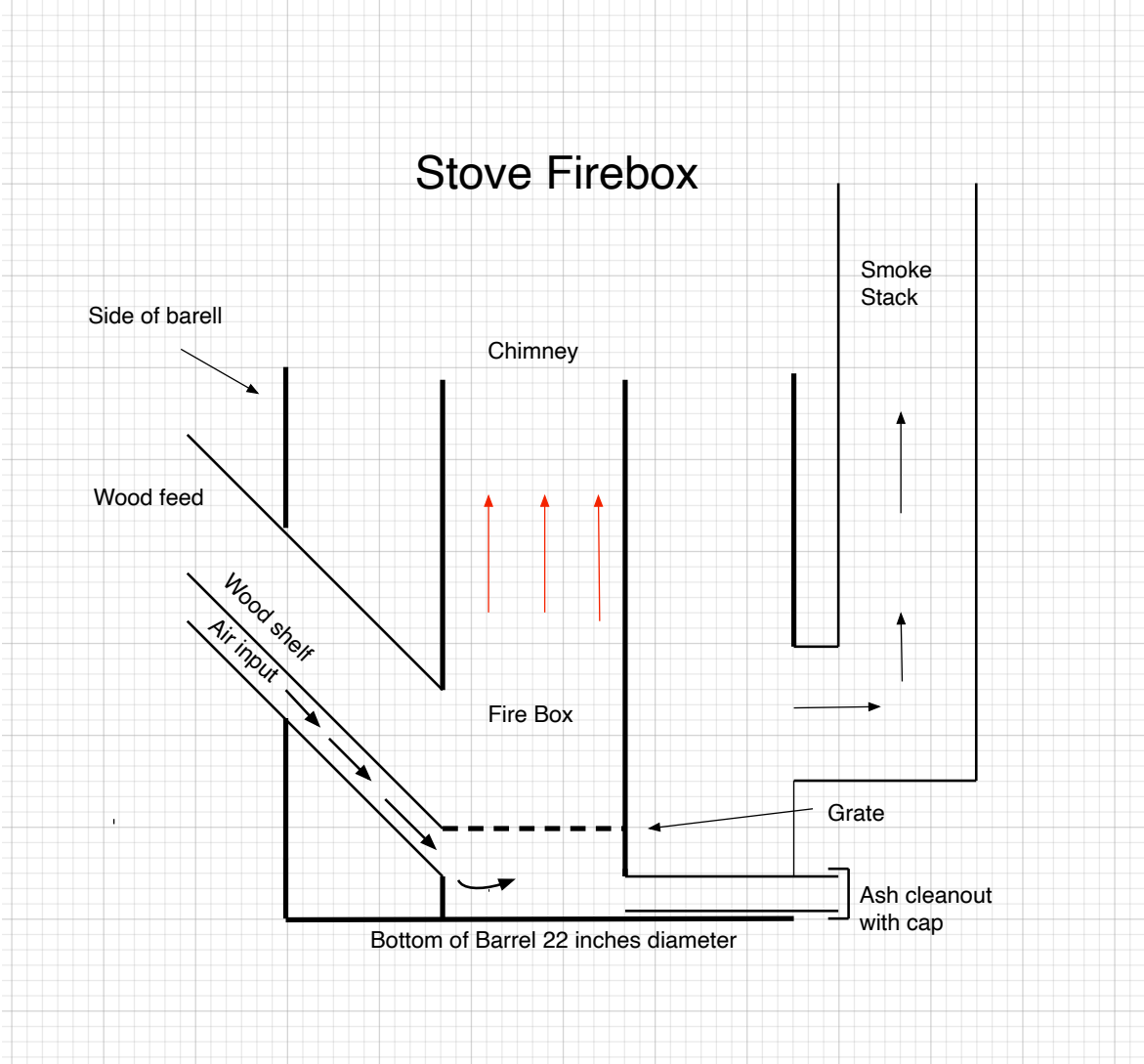

Figure 5 – Stove firebox

Gap and Height Sizes Figure 6 is a screen shot of the interactive excel spreadsheet that solves the Winiarski equations. The variables that need to be imported are highlighted, and the results appear in red. Figure 7 provides the output for this model for stoves with two common chimney sizes; 6-inch and 8-inch. Note that in order to fit an 8-inch chimney into a 55-gallon drum we had to somewhat reduce the length of the chimney, which is not a critical dimension. In the Aprovecho publication they state that the chimney should be “about” 3 times it’s diameter.

Interactive spreadsheet, insert your measurements into the highlighted cells to calculate Gap sizes and Heights					
Correspond to accompanying plans					
Measurement Needed					
Chimney inside diameter		8			
Sap pan diameter		21			
Barell height		34	(55 gallon drum - change if using a different size)		
Barell top diameter		22	(55 gallon drum - change if using a different size)		
Step one Detrmination of Chimney Height					
chimney	Height #1				
Dia inches	Chimney height				
8	24				
Step Two Gap sizes					
Gap A Top of chimney to bottoim of sap pan					
Chimnay dia	area	Circumference	Chimney Gap		
8	50.3	25.1	2		
Gap B Outer edge of donut to bottom of pot					
Sap pan dia	Circumference	Pot edge gap			
21	66.0	0.76			
Gap C Edge of donut to side of barell					
			The donut will be as large or larger than the sap pan.		
Donut dia	donut rdius	donut area	Starting with sap pan dia, adjust donut dia until DIFFERENCE is close to chimney area		
20.5	10.25	330.1			
	Barrel Radius	Barell Area			
22	11	380.1			
DIFFERENCE					
50.07					
Barell dia	donut dia	total Gap	Gap C		
22	20.5	1.5	0.75		
Step 3 Placement of fire grate					
Pot drop	Gap A	Height #1	Height #2	Barell Ht	Height #2 is distance of grate from bottom of barrel
6	2	22	4	34	(IMPORTANT for 8 inch chimney reduce chimney height to 22 inches)
Step 4 Dimensions of ash deanout and wo Shoot					
	Height	Width			
Ash clean out	2	3	(non-critical)		
	chimney area	square dimensions			
Wood shoot/ Air intake	50.3	7.1			1.5
Wood shelf	APPROX. 1/4 of squre dimensionsfrom bottom		1.8		

Figure 6 – Gap size spreadsheet

Barrel height	34 inches	6-inch diameter chimney		8-inch diameter chimney
Barrel diameter	22 inches			
Sap pan diameter	21			
Height #1		18.0 – inches		24 (reduced to 22)
Gap A		1.5 - inches		2.0 - inches
Gap B		0.4- inches		.8 inches
Gap C		0.50		.8 inches
Height #2		4.5-inches		
Ash cleanout		3-inches x 2-inches		
Wood shoot (45degree angle)		6-inshes round	Square 5.3x5.3 in.	
Wood shelf (1/4 distance from bottom)		1.5-inches	1.3-inches	

Figure 7 – Gap sizes and Heights for 6 and 8-inch diameter chimneys

Note: theoretical gap sizes and what you can actually cut out will vary.
Don't worry about a tenth of an inch. We'll "tune" the stove later.

2. Other Key Components

The grate - seen in figures 3 and 5. The grate defines the bottom of the firebox. It is positioned by drilling two holes through the chimney and sliding two rods or bolts through for the grate to rest on.

Wood feed shoot – seen in figure 5. The wood in a rocket stove burns like a cigarette, only at the end in the firebox. Having the wood feed shoot at a 45-degree angle, helps the unburned wood drop into the firebox. The shoot has a wood shelf approximately $\frac{1}{4}$ of the distance from the bottom. The shelf meets the grate, allowing the wood to smoothly slide into the firebox and for air to enter below the grate and be drawn up through the firebox, burning any coals that may accumulate. The wood shelf should be tack-welded to the sides of the wood shoot before welding it on to the chimney.

Ash cleanout. - Ash falls below the grate onto a metal plate welded to the bottom of the chimney. The plate provides stability to the combustion chimney, so it won't fall over, and protects the bottom of the barrel from the hot embers that fall through the grate. A cleanout box needs to be fabricated so you can remove ashes from outside the barrel. The cleanout needs a cap, so that air enters only through the wood shoot.

The stack- Air is drawn in through the wood feed, the heat of combustion expands those gasses and they scrape under the pan transferring heat to the sap. Even though we are achieving near complete combustion, those expanded hot gasses have to go somewhere. In many rocket stove designs they simply escape around the sides of the pan into the atmosphere; i.e. no stack, like a camp stove. However, in a rocket sap evaporator this would be a serious disadvantage. You would be working across the stream of exiting hot gasses. The solution is to draw the hot gasses back down the barrel and out a "smoke" stack, figure 5. The stack should be attached low on the barrel so that you are not drawing more from one side than the other.

To balance air flows, the stack diameter and cross-sectional area should be the same as the chimney and wood shoot. However, because of the positive draw of hot gasses rising up the smokestack, in the 8-inch chimney stove we built, a 6-inch stack seems to be sufficient. It is also what was available at my local hardware store. Who knows, maybe an 8-inch stack would work even better?

The Donut or flame spreader – The donut is the most complex component of this stove. It is a truncated cone, where the distance from the plane of the top of the chimney to the edge of the pan decreases at a rate that keeps the airspace volumes constant. If the distances are too small it restricts the airflow, resulting in incomplete combustion. If the distances are too large the hot gasses are not forced close to the pan, resulting in less than optimal heat transfer.

The question is how do you make that truncated cone? Notice that you are cutting out a circle from within a circle, making a donut. Also notice that there is a wedge cut out of the donut. When the edges of that wedge are forced together and welded you will have a truncated cone with the proper pan to flame spreader distances. CADD drawings appended to this document provide precise radii and angular measurements for 6-inch and 8-inch chimneys in a 22-inch diameter 55-gallon barrel.

But how to make it? After cutting out the donut and the wedge, you will need to work the inner edge of the donut with a hammer as you force the edges of the wedge together. Try it on a cardboard cutout to see how this works. Also use thin steel, 1/16-inch is about the maximum that you will be able to force closed.

When you are done, the donut should sit nicely on top of the chimney giving you the proper distance to the pan on the edge (Gap B) and the proper spacing from the edge of the flame spreader to the side of the barrel (Gap C). I have found no need to weld this on, it just sits on top of the chimney and is supported by the insulation. You may have to inset bolts through the barrel to hold the donut in place without welding it.

1. Rocket Stove to Rocket Sap Evaporator The longer the sap is exposed to heat the darker and more robust the flavor of the syrup. One reason so much “backyard” syrup is very dark is that it tends to be evaporated slowly. One reason so many backyard syrup producers look so tired, is that this takes a long time. Rocket stoves give you a rapid boil. The Rocket Sap evaporator further increases the rate of evaporation by replacing a deep pot with a large shallow sap pan. The more surface area exposed to the hot gasses and the shallower the liquid in the pan, the greater the rate of evaporation. Our 21-inch diameter stainless steel sap pan rests on the top of the barrel with a 1-inch flange. The bottom of the pan sets 6-inches down in the barrel, figures 3, 4, and 8.

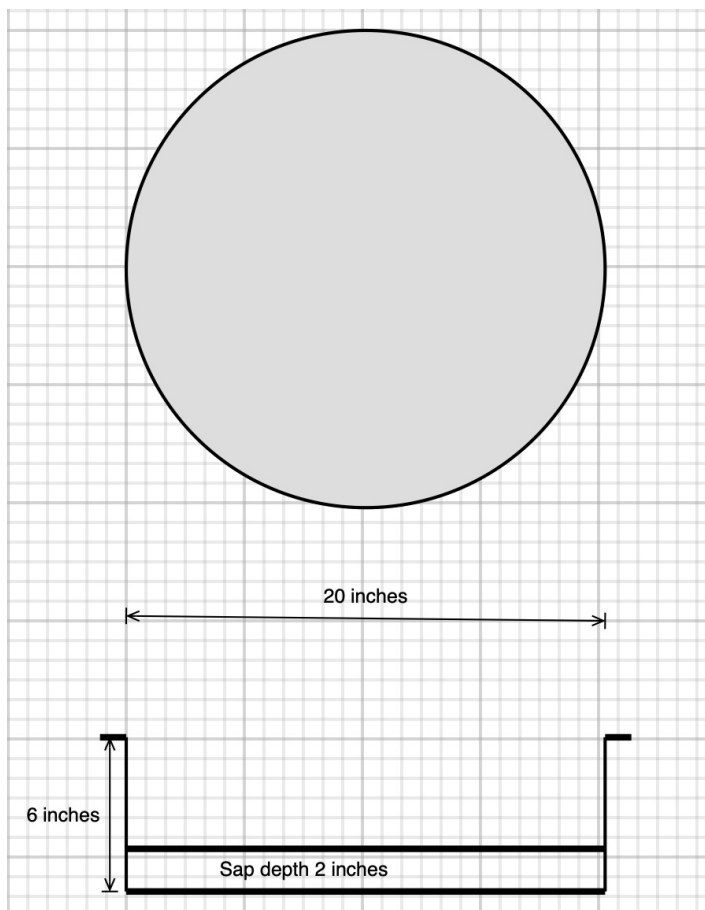

Figure 8 – Sap pan design

The Rocket sap evaporator should be run with a minimum of 2-inches of sap in the sap pan. More is okay and safe, and less is also okay, as long as you are paying close attention. If you run out of sap the sugars in the syrup you have been concentrating turn to a black and bubbly mess and you spend the next day trying to clean the pan. If you have to go in the house to get a sandwich or use the facilities put 4 inches in the pan.

When the evaporator is really cooking, steam will be bellowing out and the sap level dropping. You can periodically add a few quarts, but the cold sap kills the boil. A better solution is to purchase a bucket with a spigot. Rig this on a step ladder next to the evaporator, making sure it is secure, and set the drip such that the sap level in the pan stays constant. Sap dripping in equals water being evaporated. You may need a bit of tubing attached to the spigot to direct the dripping sap into the sap pan. The example in figure 9 can be purchased online for less than \$20, and, as you can see, it has good uses once the maple season is over.

“Mission control, this is rocket sap evaporator ready for final checks prior to lift off.”

Once you have all the pieces together you should do a dry run with water to learn how to operate your Rocket Sap Evaporator. Your “pre-ignition” check list should include:



Figure 9 – Sap feed bucket

- Make sure the evaporator is level
- Have a good supply of finely split, and dry firewood
- Make a cover - a plastic tarp and someone who knows how to sew a sleeve on a shirt can make you a cover. Your stove will most likely sit outside and you don't want the rock wool insulation to get wet (figure 10).
- Make sure all holes on the barrel are sealed. Air should only be drawn in only through the wood feed shoot. Aluminum flashing and a pop rivet gun can seal it up tight.
- You may have to “tune” your stove to get optimum performance. When first lit the smoke comes back out the wood feed shoot. After the chimney has warmed the air flow reverses and smoke is drawn up the stack. Stack emissions will turn clear as the system gets hot. If you are having trouble getting this reversal it could be that your gaps are too small restricting air flow. That happened in the stove I just built. I had to make risers to lift the sap pan the proper distances off the barrel rim and then seal the resulting gap with 1-inch rope gasket material (figure 11). If you can't get a good boil all across the bottom of the sap pan the distances may be too great and you may have to raise the chimney a bit off the bottom of the barrel.

Figure 10 – Cover



Figure 11 – Pan risers

“Rocket sap evaporator, you are cleared for takeoff”



Figure 12 – A full boil

Figure 13 – Looking down the donut



With your rocket sap evaporator, the right trees, a few spouts and as little knowledge you are ready to “takeoff” into the world of maple syrup making. For some of you this will be a hobby, a great thing to do with the kids, an excuse to get outside in the early spring. Twenty trees and you can make all the syrup your family will use for the year. For others this will be just a start. There are always more trees you can tap. By the time 20 trees becomes 200 you’ll have moved up from your Rocket Sap Evaporator to a commercial rig and be selling maple syrup at your local farmers market. Either way, it’s really a lot of fun.

Also, the development of this rocket sap evaporator is a continuing process. By building one you will be part of the learning process. You’ll figure out ways to do things better than we did, and we look forward to your improvements on the process.

Here is a link to a good song to listen to while building a rocket stove.

https://www.youtube.com/watch?v=r_QZe8Z66x8

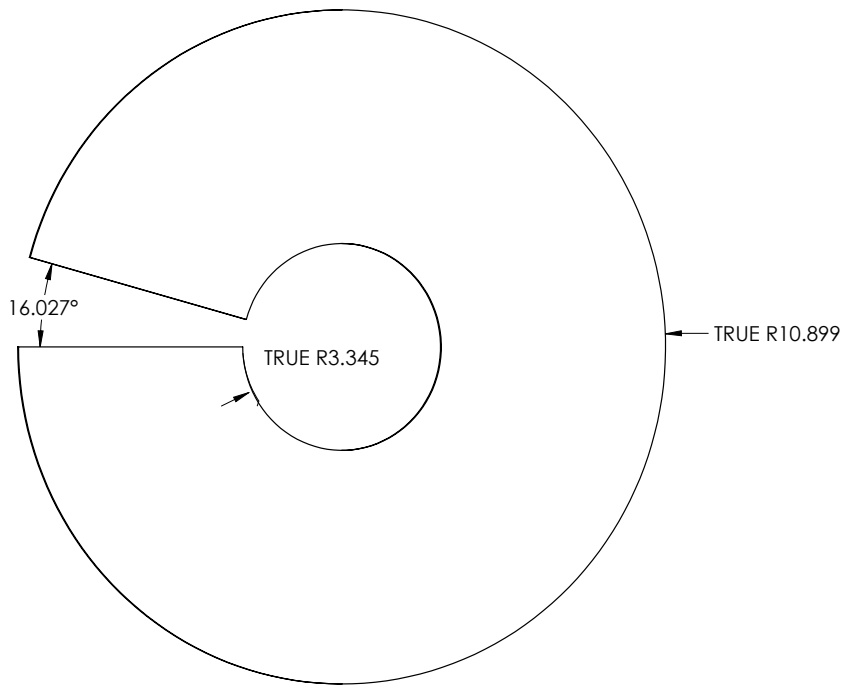

SIZE	DWG. NO.	REV
A	6" Doughnut	
SCALE: 1:4	WEIGHT:	SHEET 1 OF 1

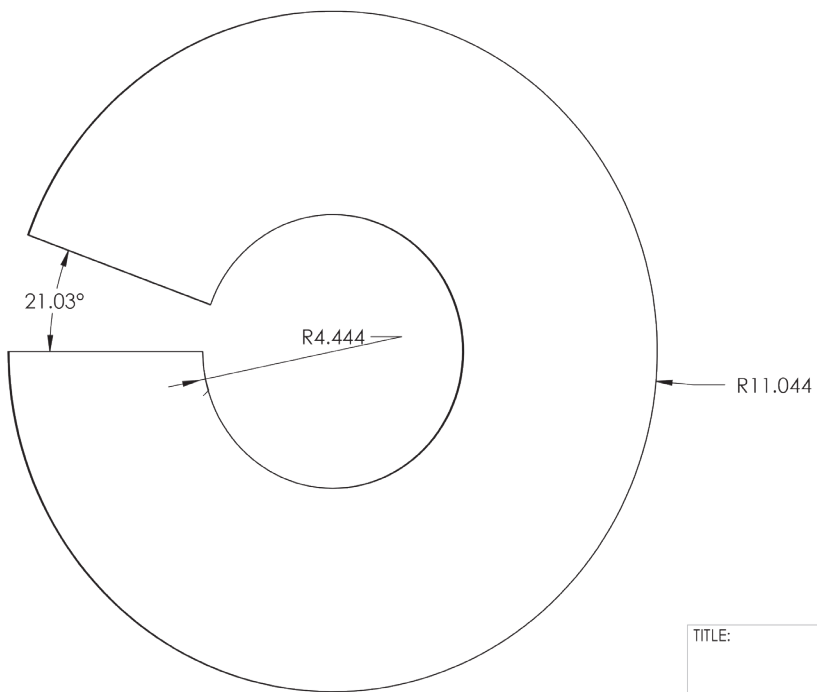

TITLE:		
SIZE	DWG. NO.	REV
A	8inch Doughnut	
SCALE: 1:4	WEIGHT:	SHEET 1 OF 1

Dimensions for the cuts needed to connect a square wood feed shoot to an 8-inch diameter chimney.

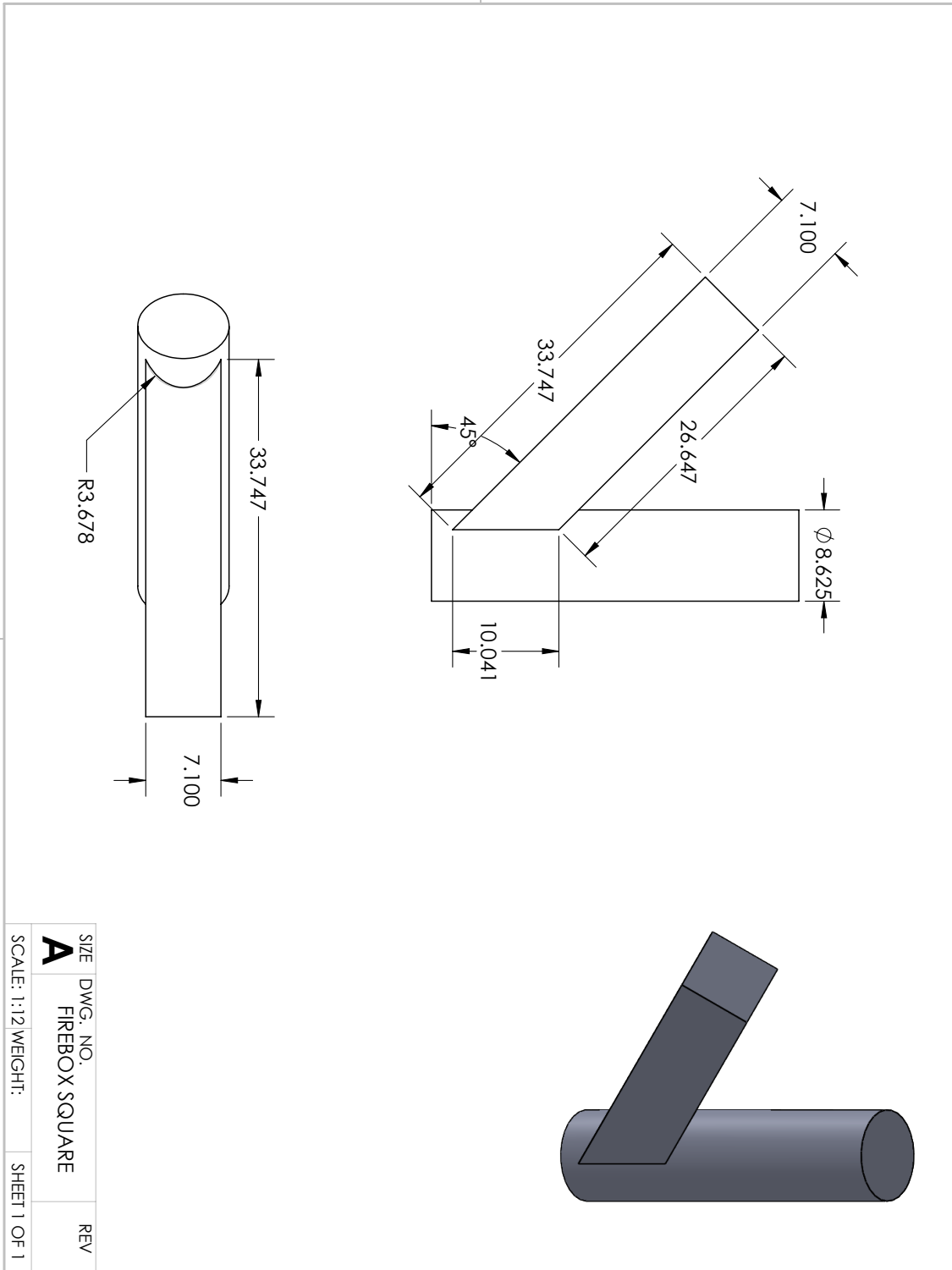

Parent Tube: 6"
Cut Tube: 6"
Wall Thick: 0"
Angle: 45°

blocklayer.com

Template for the cut needed to join 2 round pipes.
This will need to be such that pi multiplied by the outside
Diameter of the pipe (which is the pipe circumference)
equals the distance between the ends of this template.
Make this cut on the wood feed tube then trace on the chimney to
make the hole (this one is sized for a 6" pipe--line up the middle lines
and double check that the length is 18 27/32")

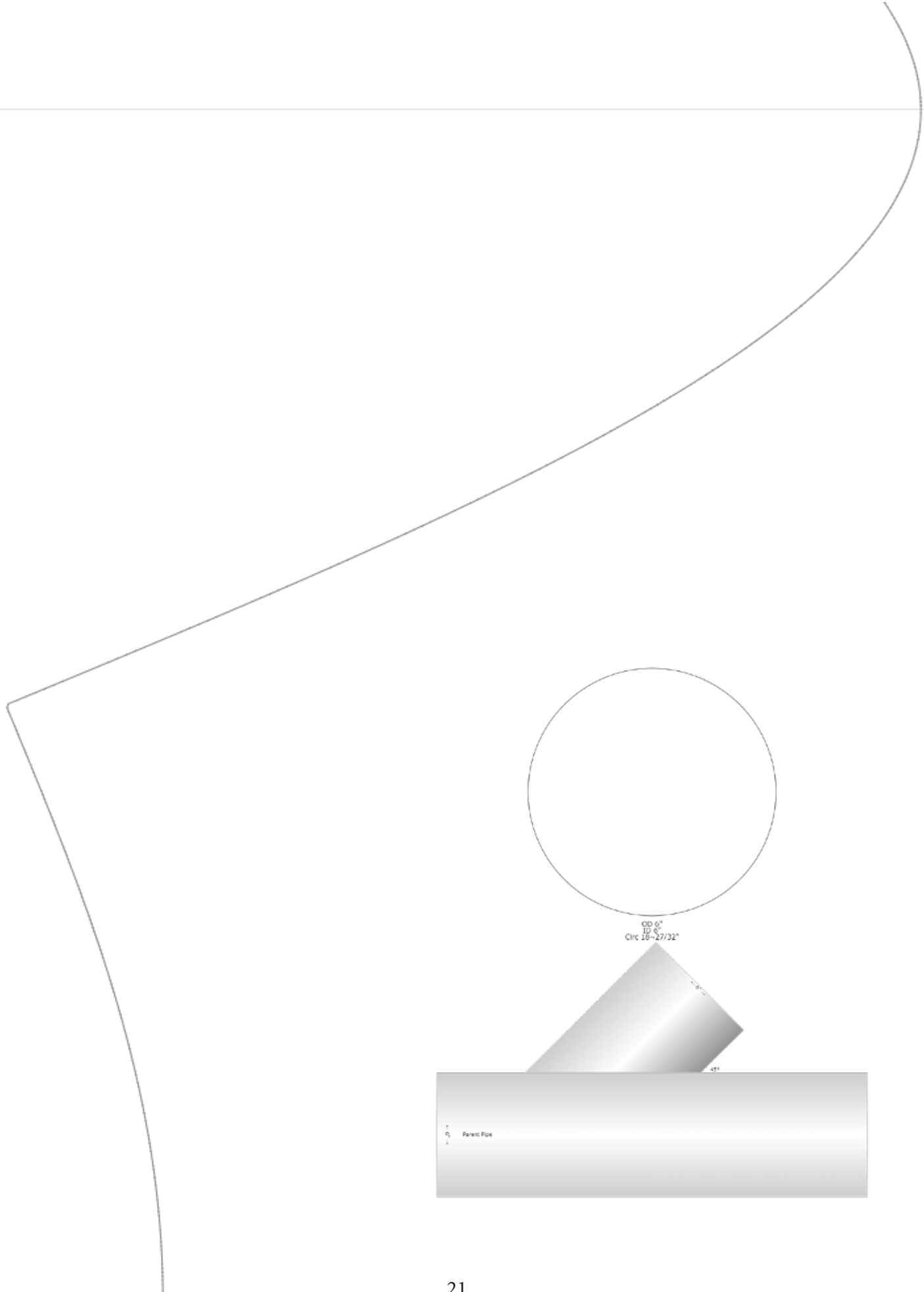

Parent Tube: 8"
Cut Tube: 8"
Wall Thick: 0"
Angle 45



← 25~5/32" →

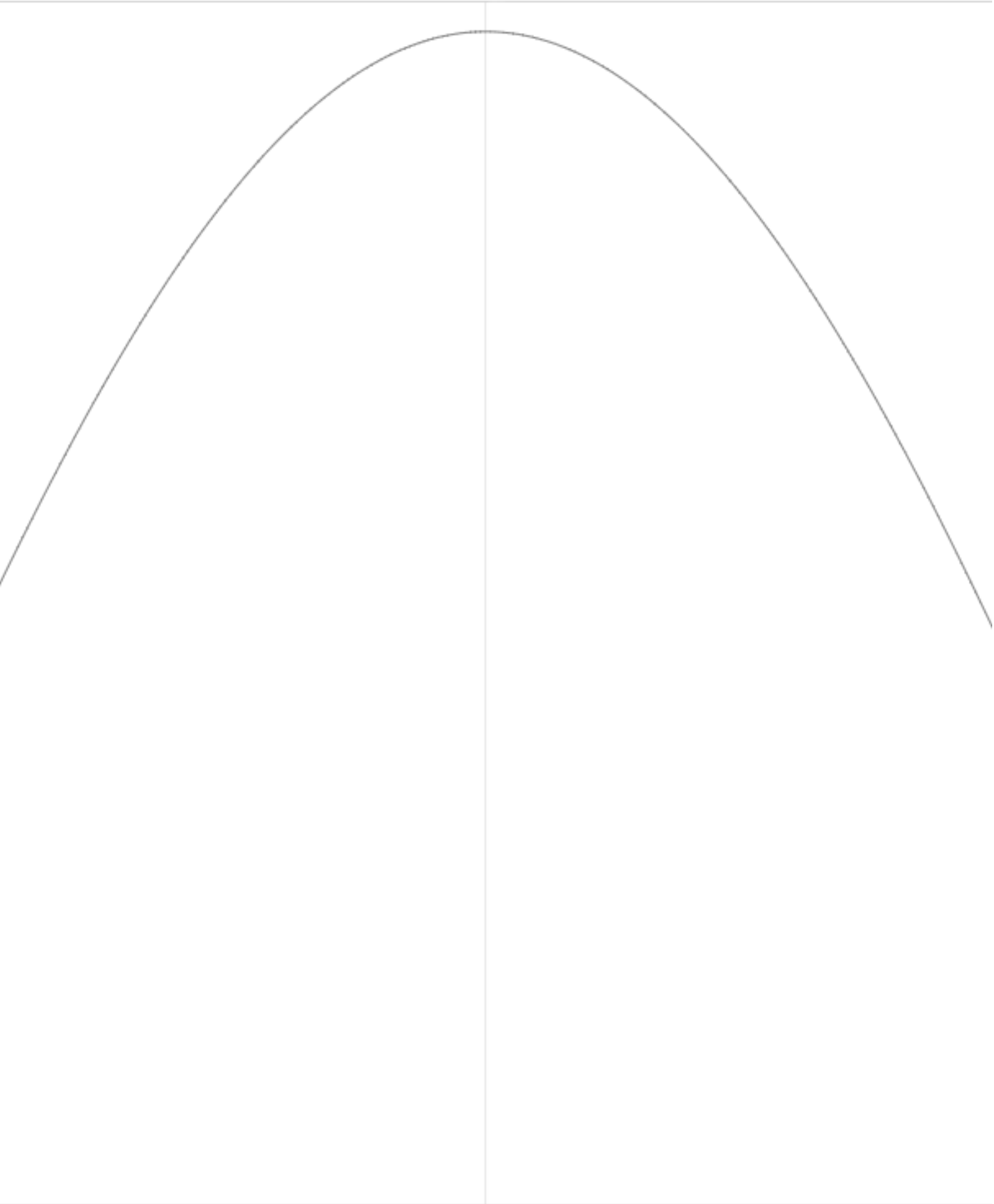

← 25~5/32" →

