

Figure 1. Schematic diagram of the diesel engine test stand (GA: Gas analyzer, CB: Control box, FS: Fuel stand, SC: sensor connection, SO: soot opacity sensor, DM: digital monitor, PC: Computer).



Figure 2. The 4-cylinder diesel engine test stand anchored to the ground and connected to a dynamometer.



Figure 3. Fuel stand that shows the fuel lines to the experimental fuel and base fuel containers and an online weight measuring unit using a load cell connected to the data acquisition system.

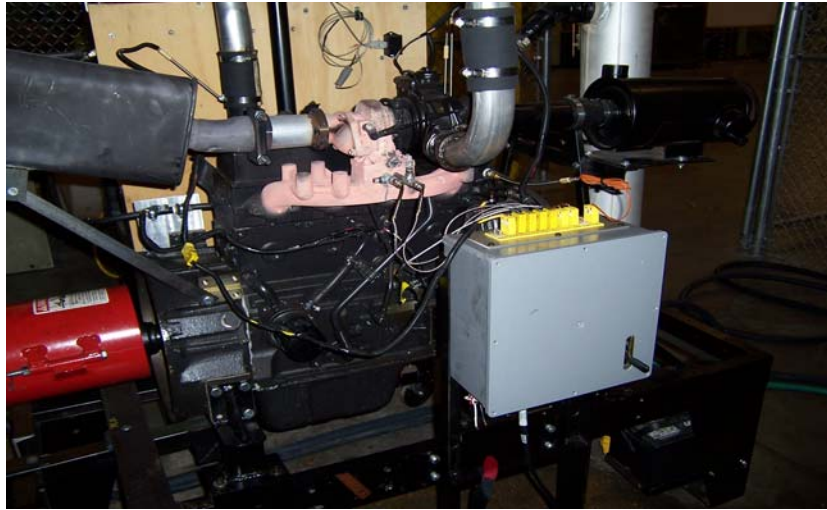

Figure 4. Control box for the DAQ terminal box, engine governor and the ignition switch.



(a)



(b)

Figure 5. Exhaust emissions analyzer (a) samples the exhaust gasses with a probe attached to the exhaust line of the engine and analyzes the gasses for CO, CO<sub>2</sub>, NO, NO<sub>2</sub>, O<sub>2</sub> and measures the exhaust temperature at the sampling location. Smoke opacity of the exhaust gasses was measured using an opacity sensor.



(a)

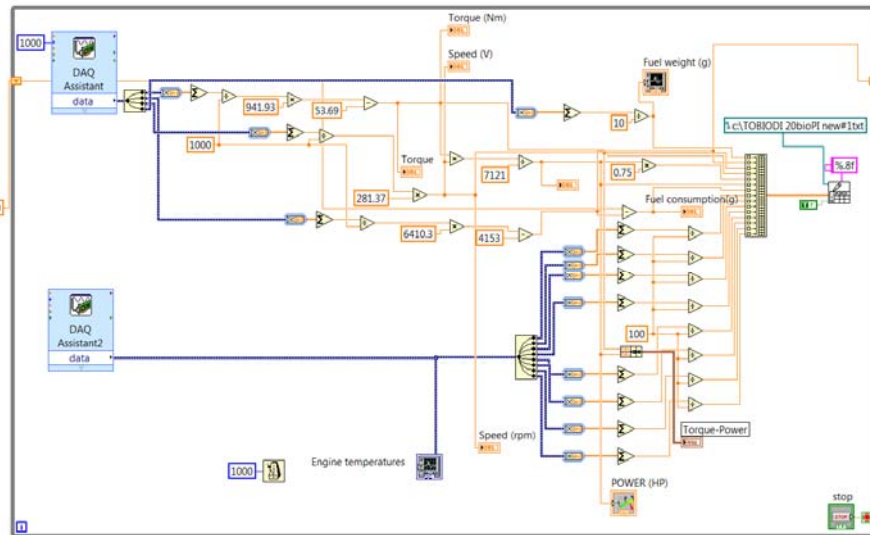

(b)

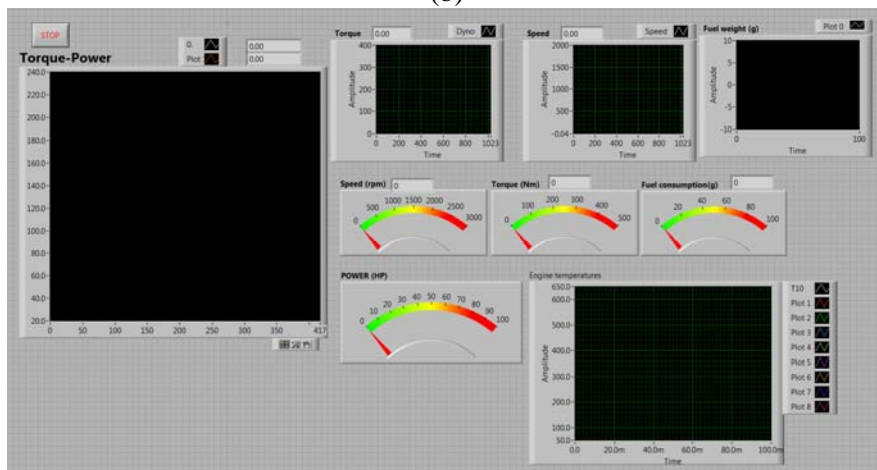

(c)

Figure 6. Computers used to capture the data (a). Block diagram (b) and control panel (c) of the computer program that acquire, display, and record the signals from the sensors on engine test stand.

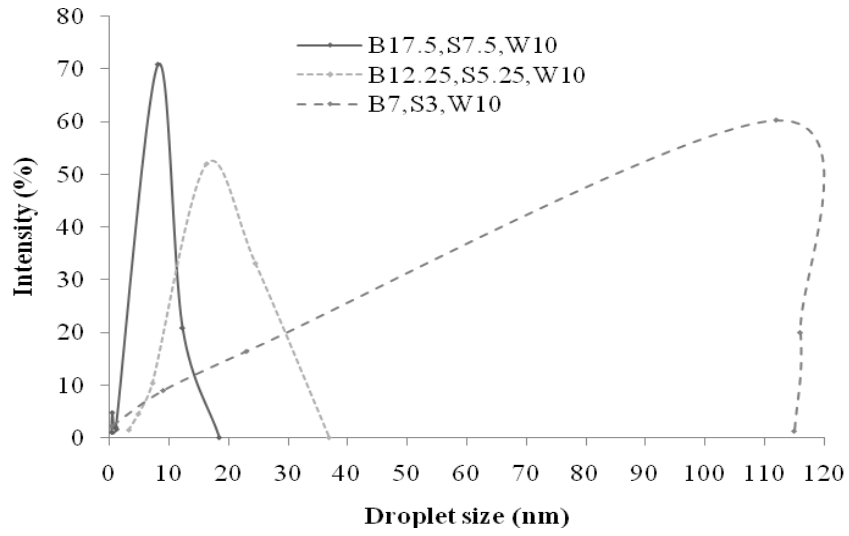
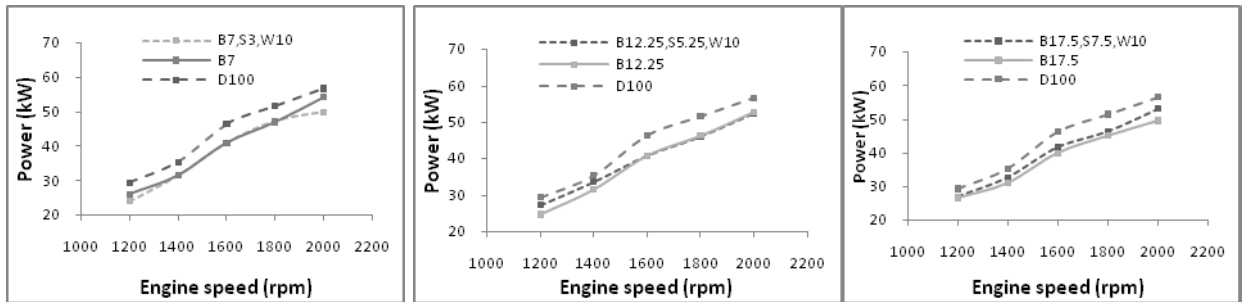

Figure 7. Water droplet size distribution in biodiesel nenoemulsions.



(a)

(b)

(c)

Figure 8. Engine brake power of different fuel compositions at varying engine speed, (a) B7, (b) B12.25, (c) B17.5 (W10: 10% water).

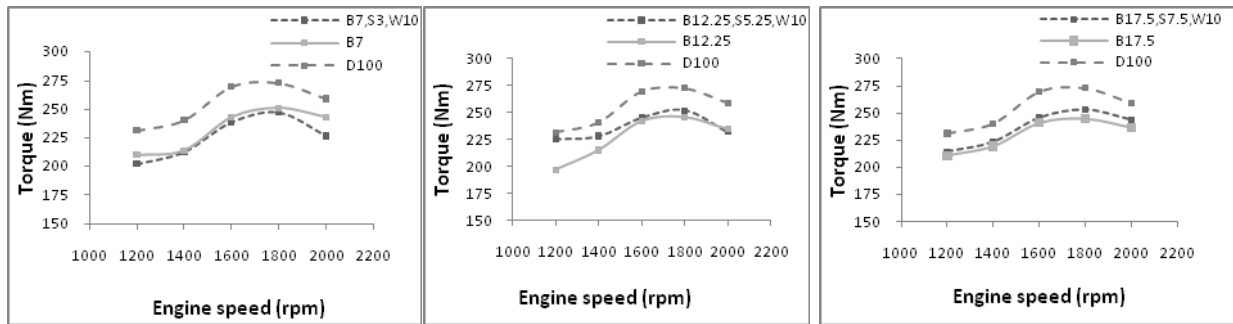

(a)

(b)

(c)

Figure 9. Engine torque of different fuel compositions at varying engine speed, (a) B7, (b) B12.25, (c) B17.5.

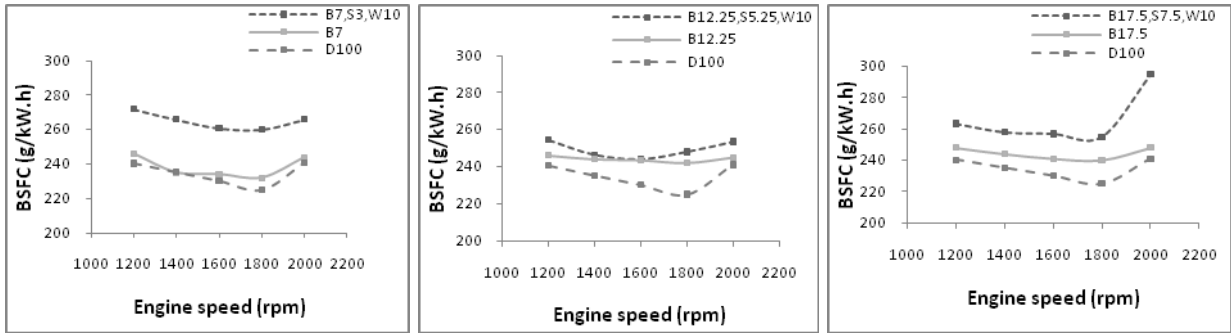

(a) (b) (c)  
 Figure 10. Engine BSFC of different fuel compositions at varying engine speed (a) B7, (b) B12.25, (c) B17.5.

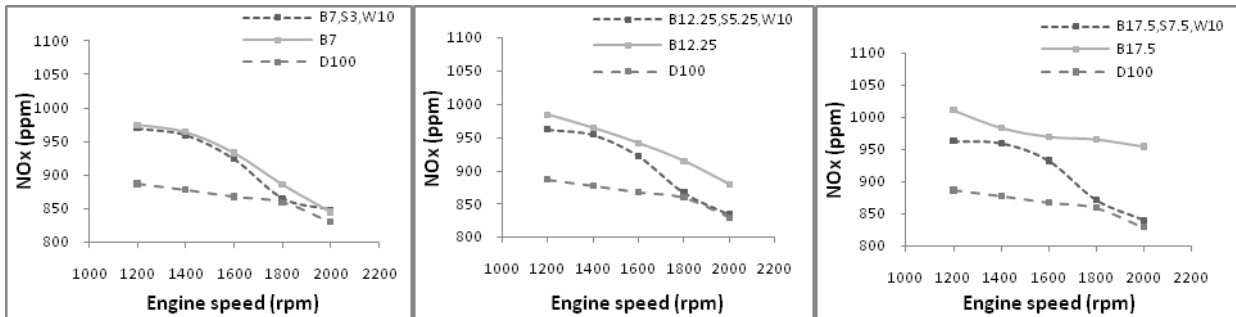

(a) (b) (c)  
 Figure 11. Oxides of nitrogen emissions at varying engine speed: (a) B7, (b) B12.25, (c) B17.5.

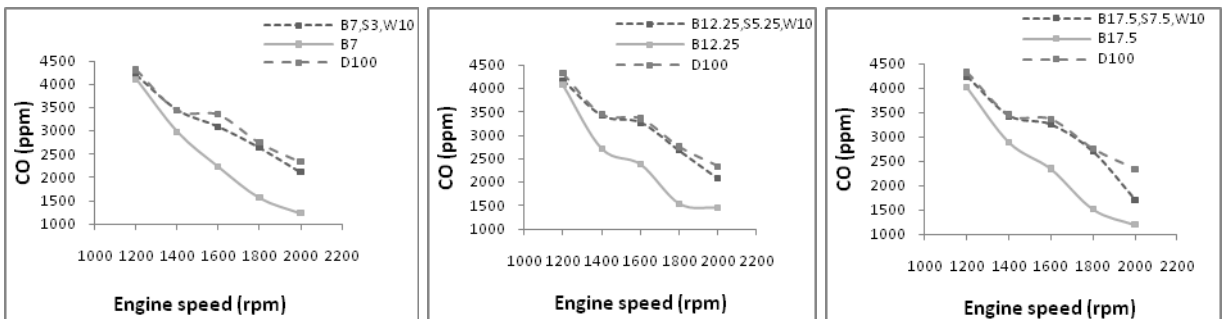

(a) (b) (c)  
 Figure 12. Carbon monoxide emissions at varying engine speed, (a) B7, (b) B12.25, (c) B17.5.

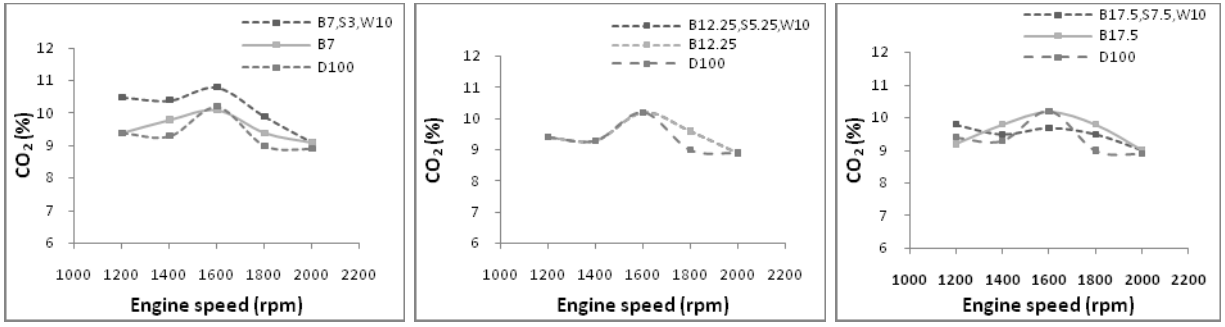

(a) (b) (c)  
 Figure 13. Carbon dioxide emissions at varying engine speed, (a) B7, (b) B12.25, (c) B17.5.

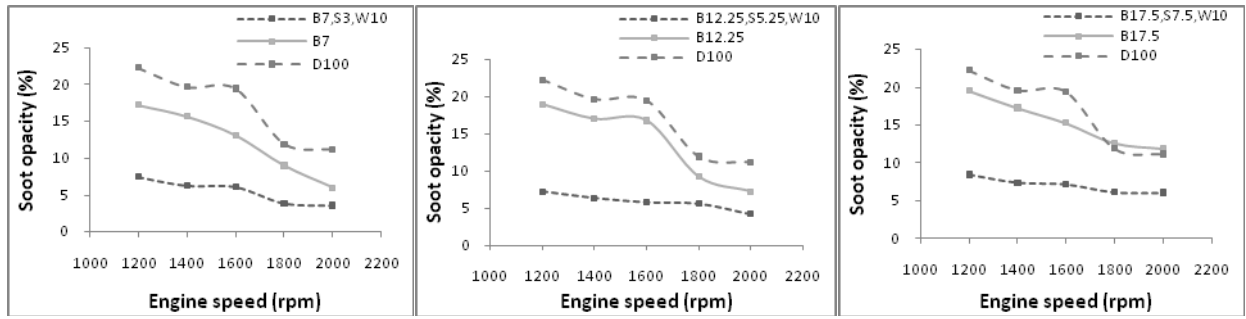

(a) (b) (c)  
 Figure 14. Soot opacity at varying engine speed: (a) B7, (b) B12.25, (c) B17.5