

Tensioner Assembly

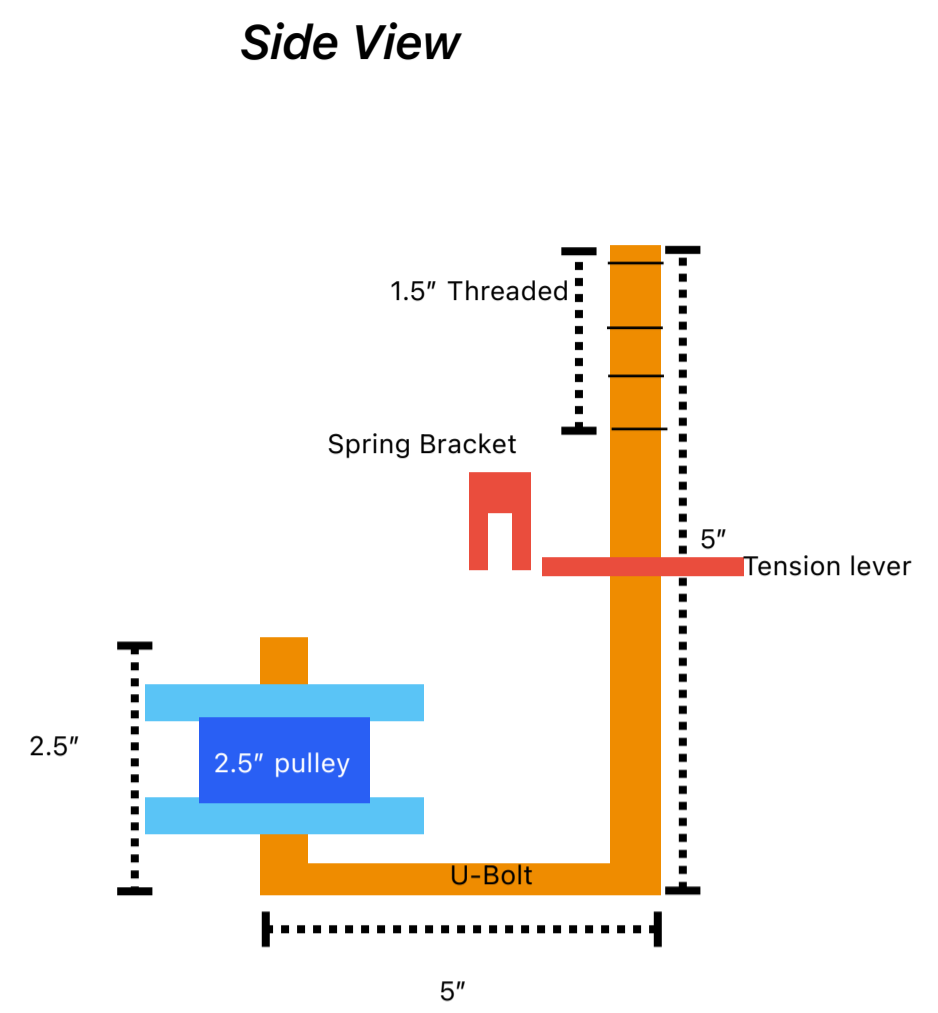

Front Tensioner Assembly

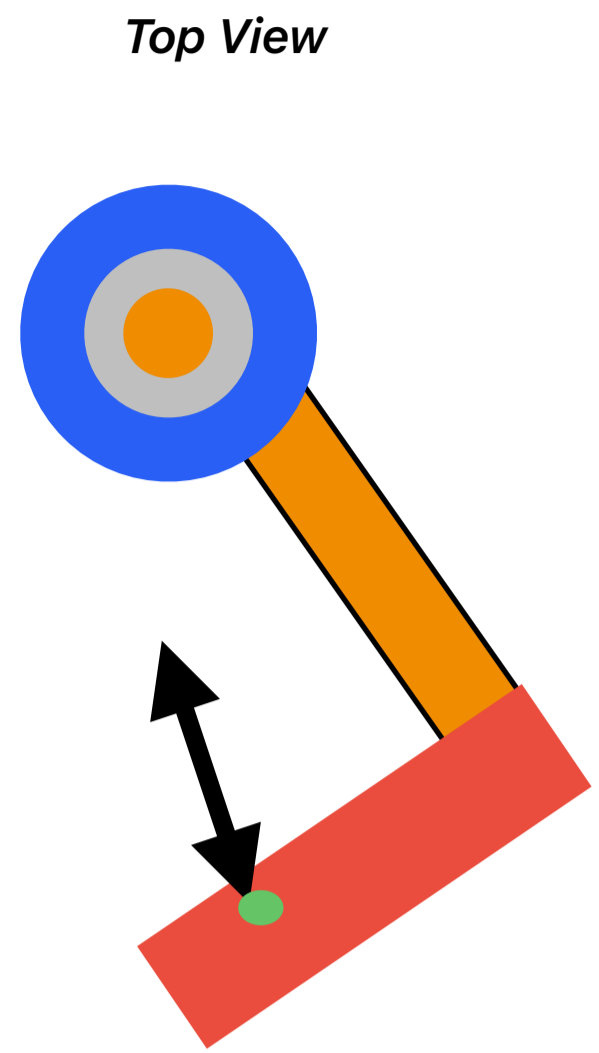
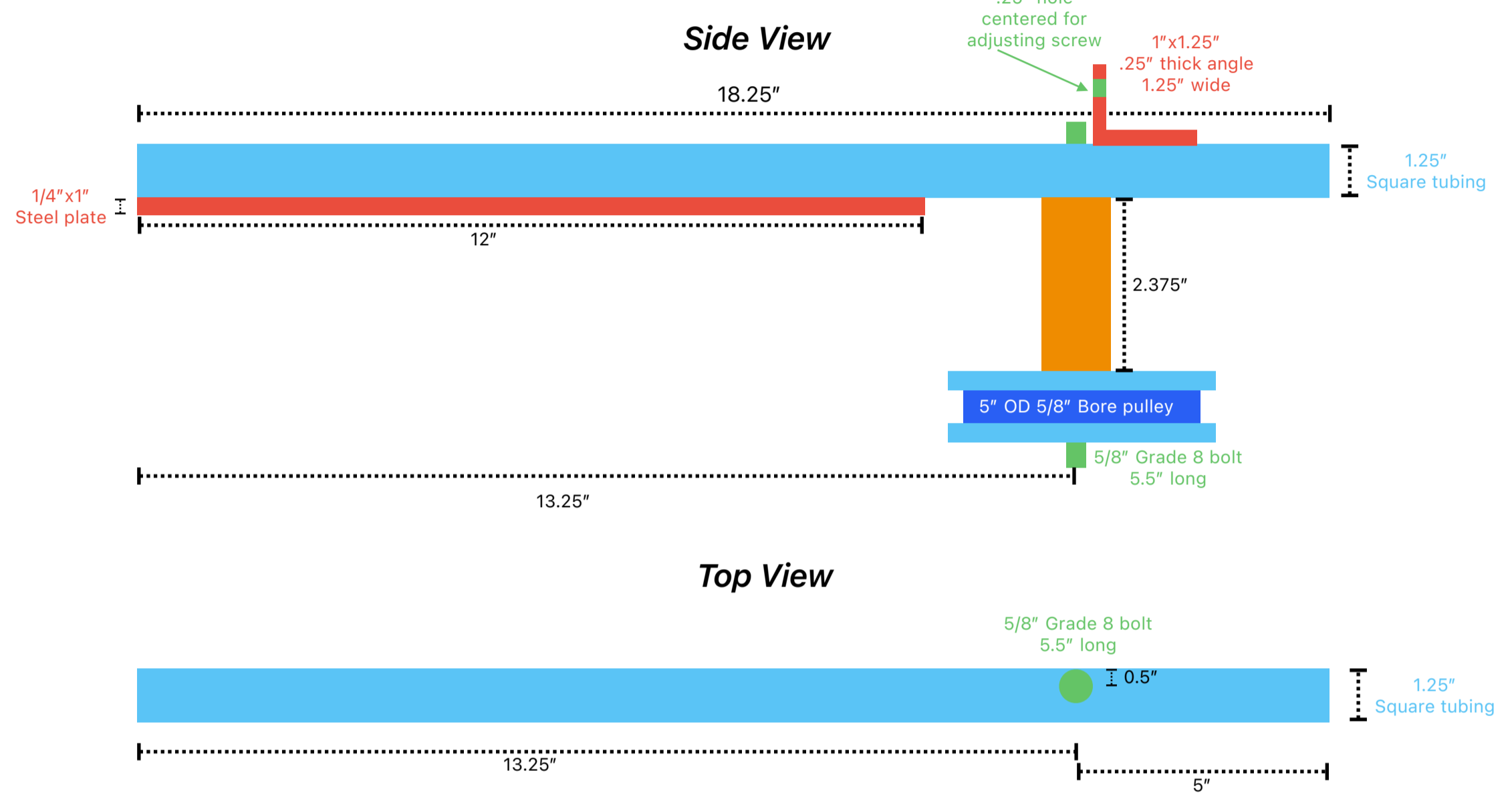

Picking Belt Driveshaft/Motor Assembly

Step 1

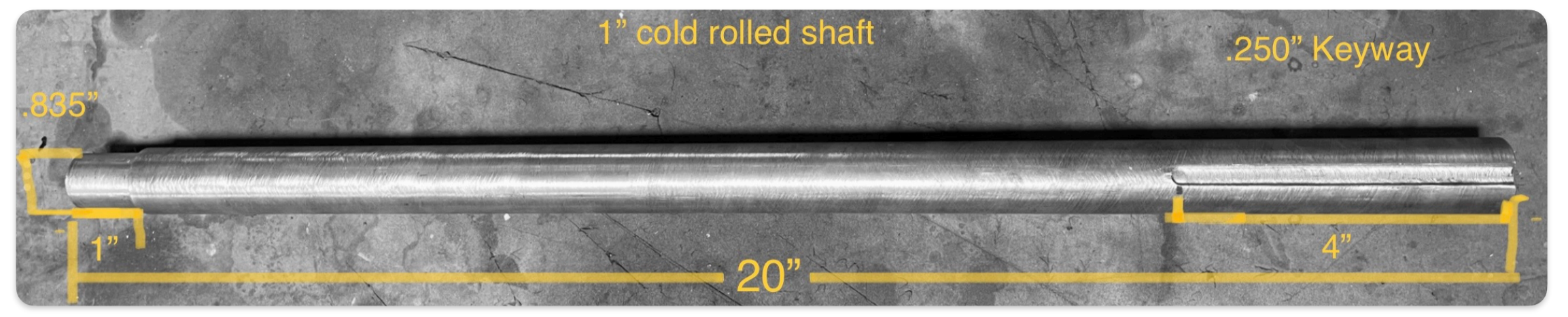

Step 2



Step 3

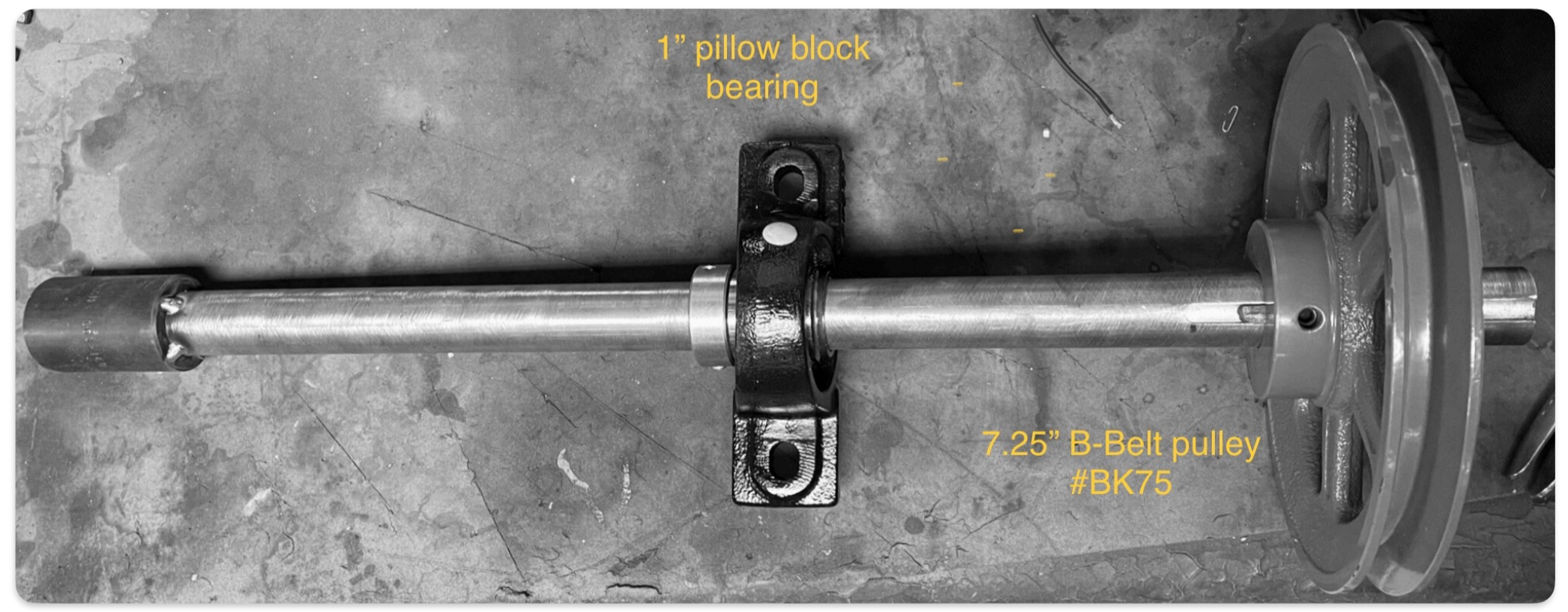

Step 4

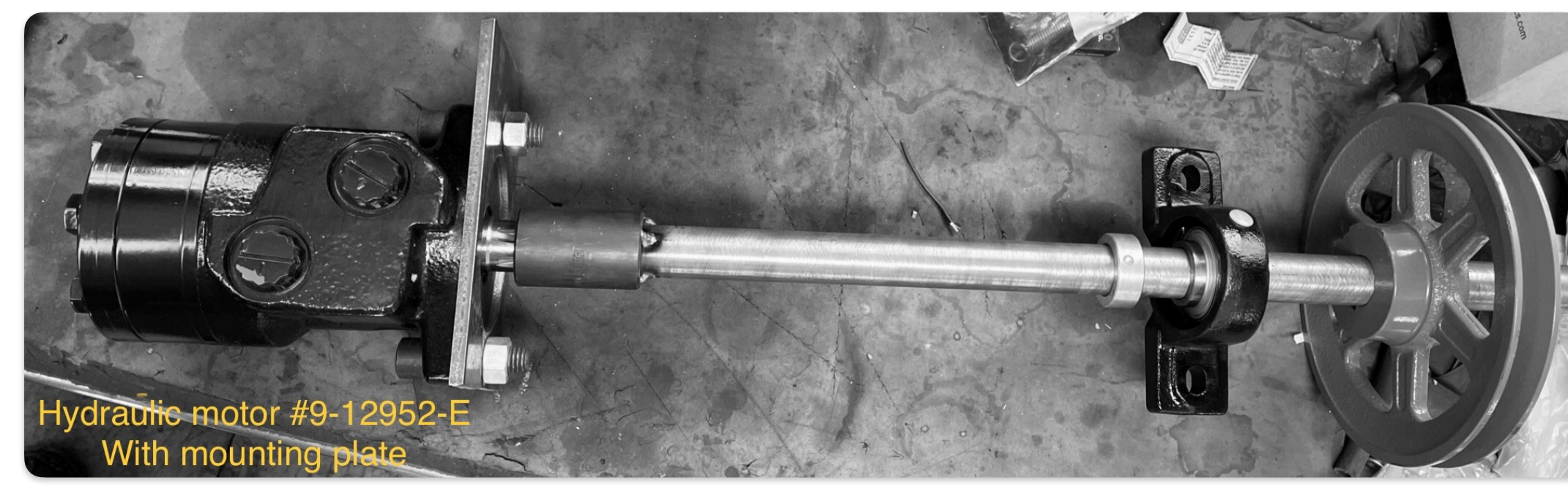

Picking Belt Drive Shaft Bearing Bracket

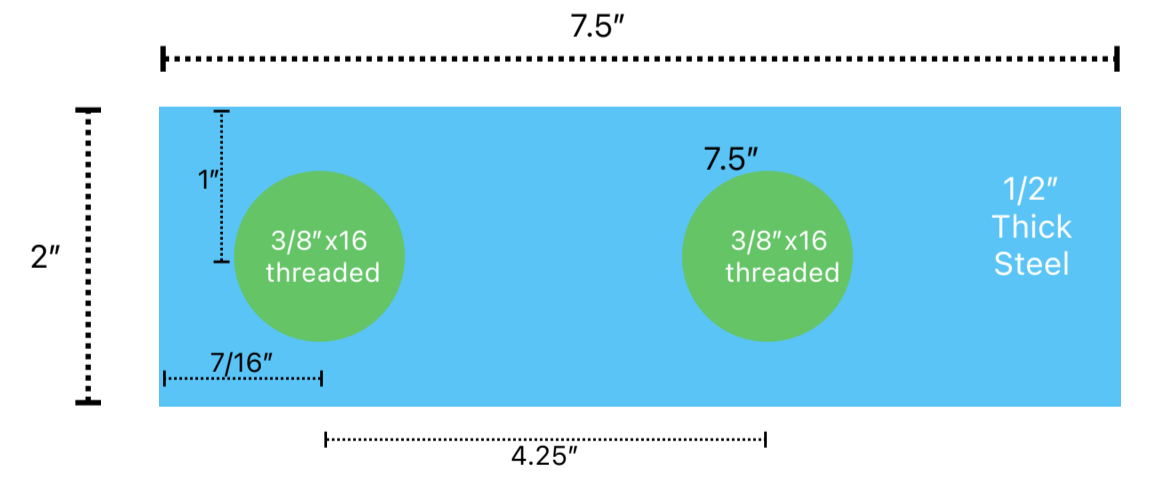

Picking Belt Drive Motor Mount Plate

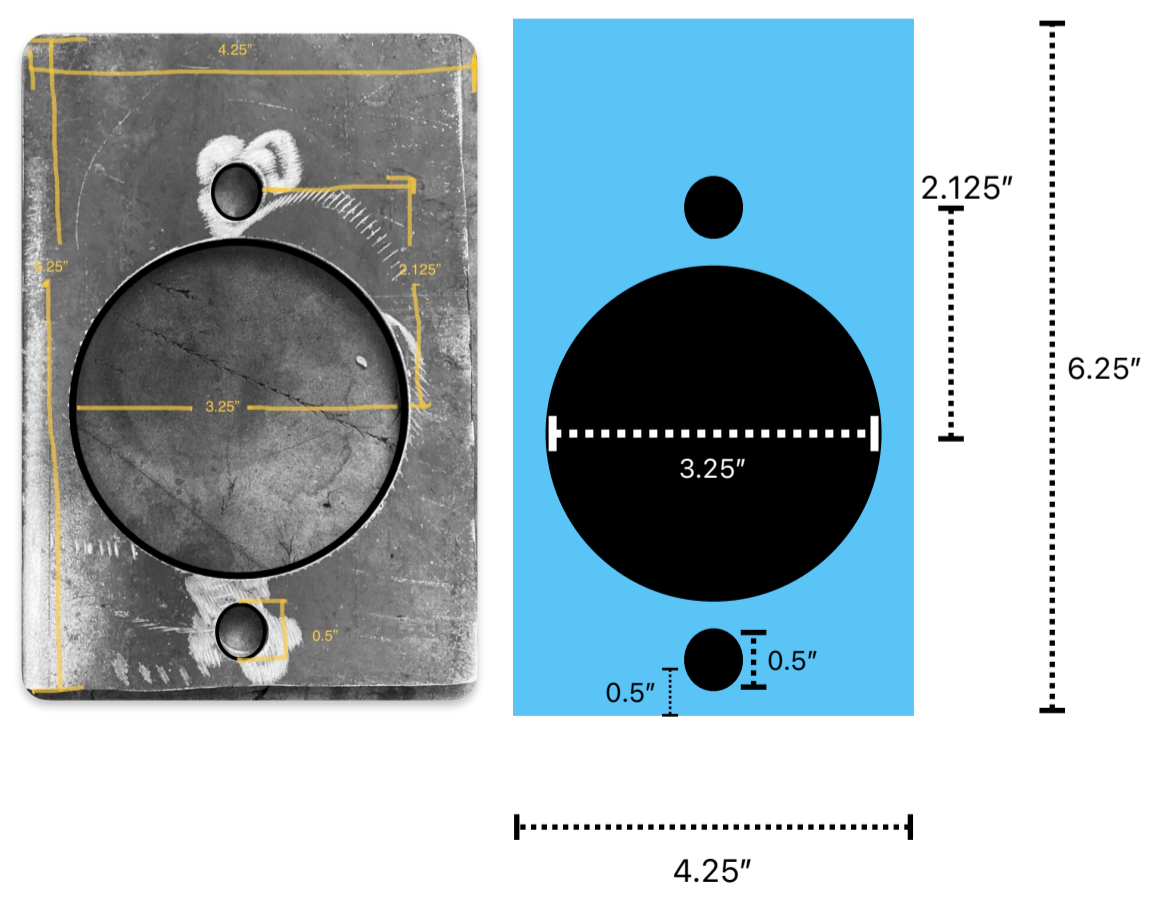

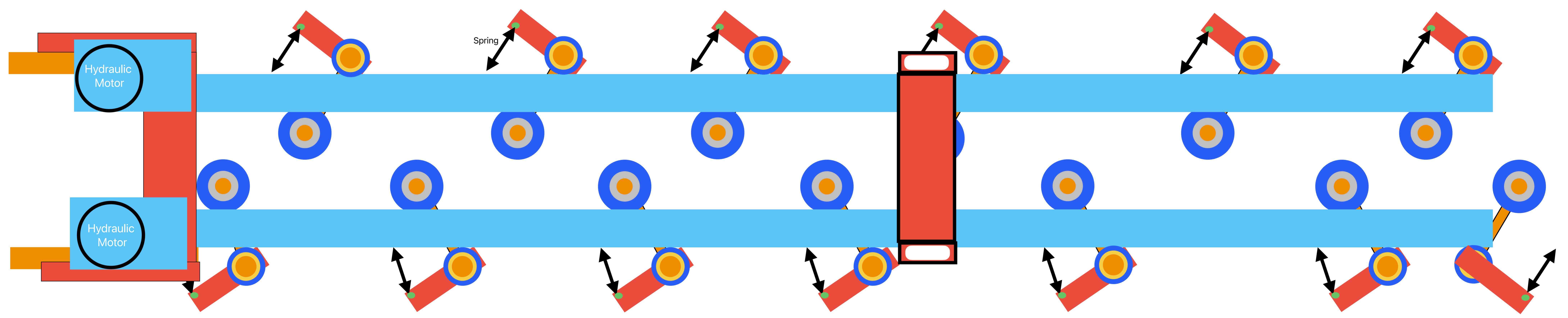
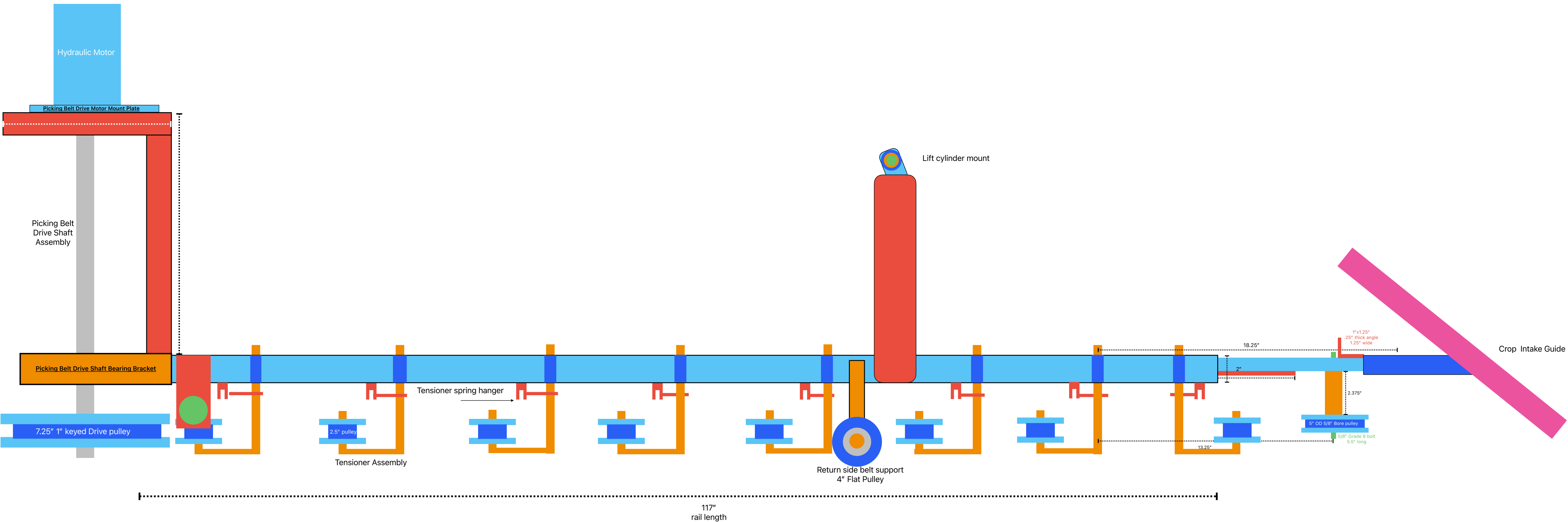

Tensioner Assembly

Top View

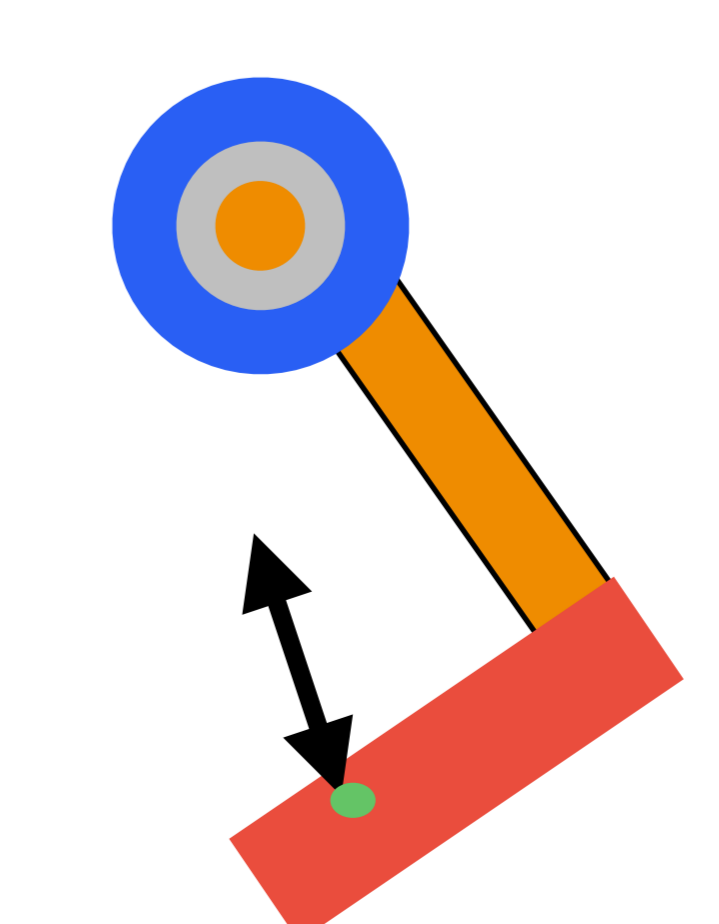

Side View

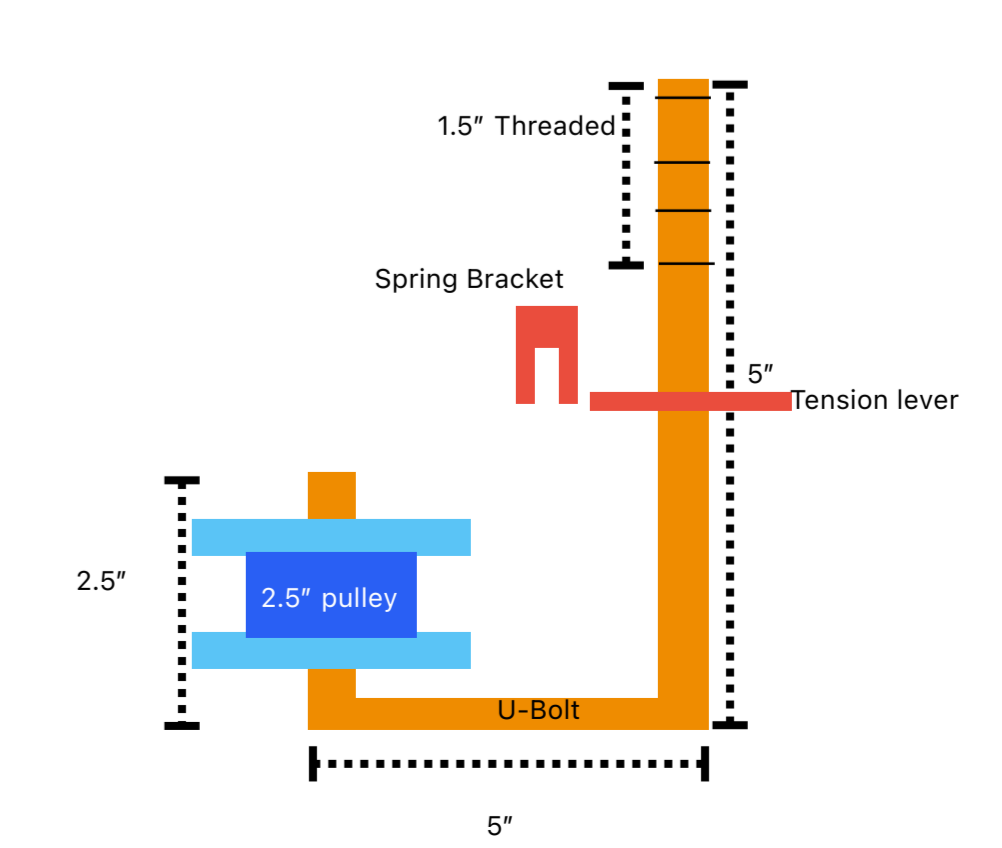

Frame/Platform

4"x3"x3/16" tube steel

Front View

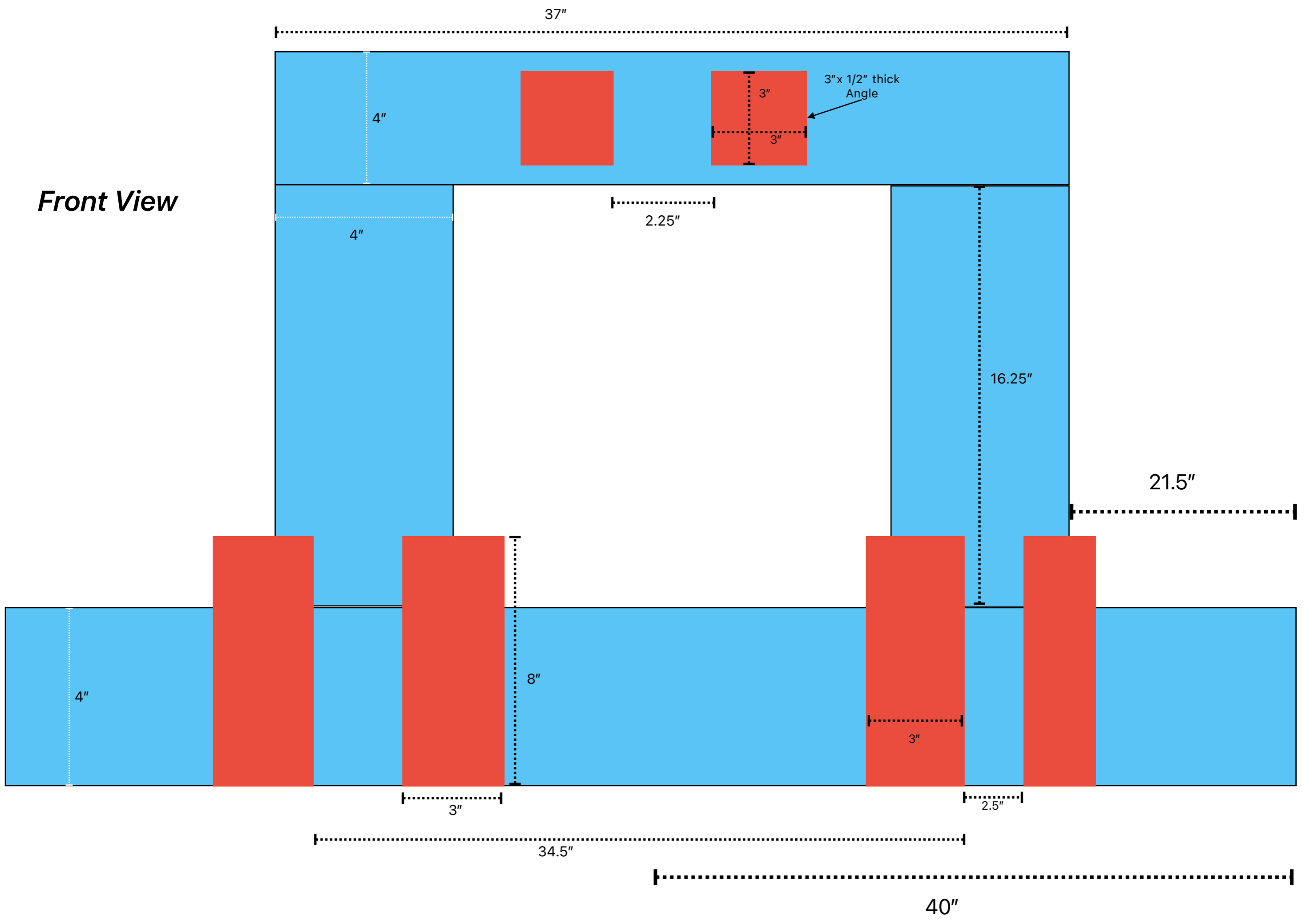

Side View From Right

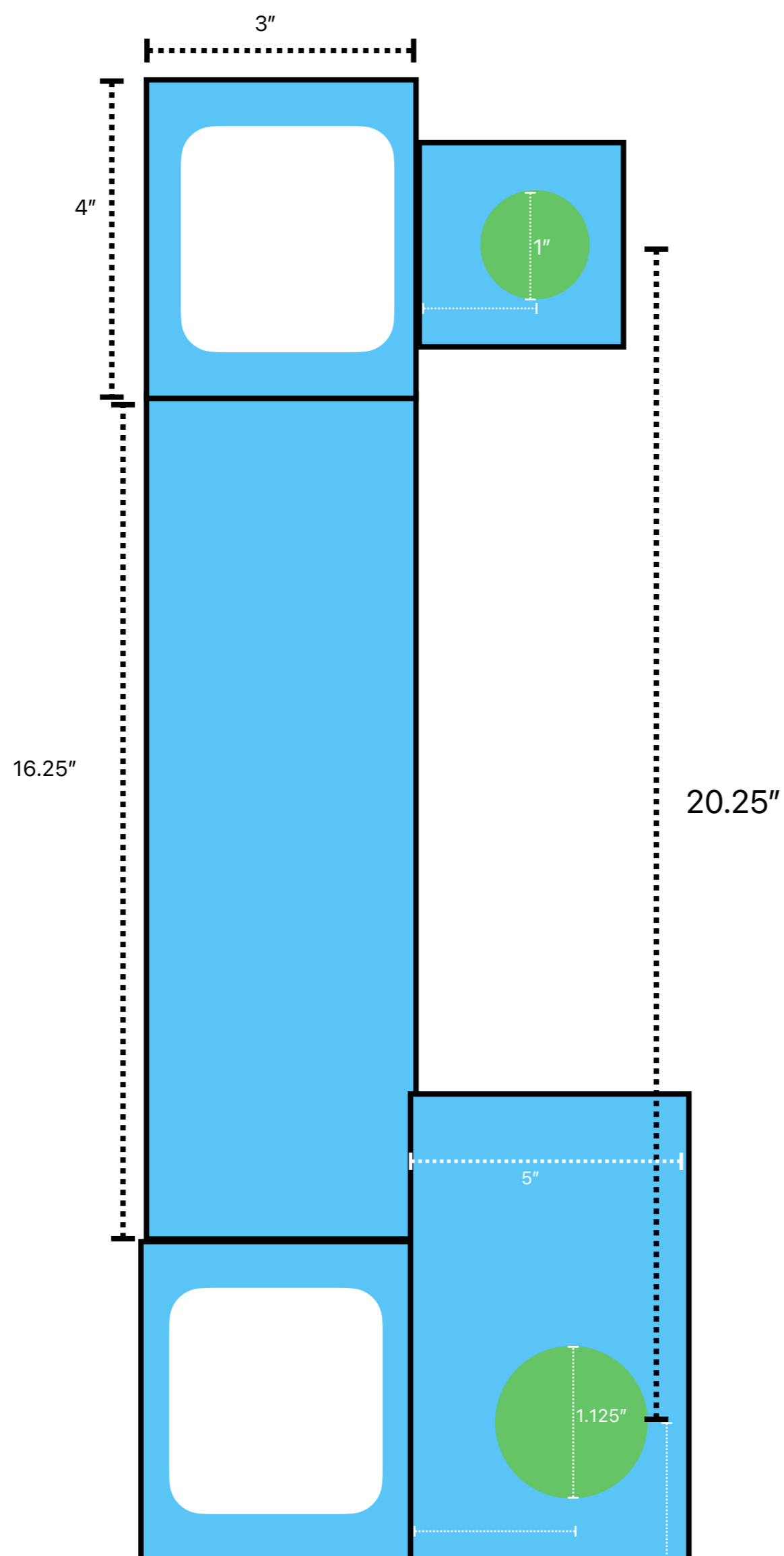

Top View

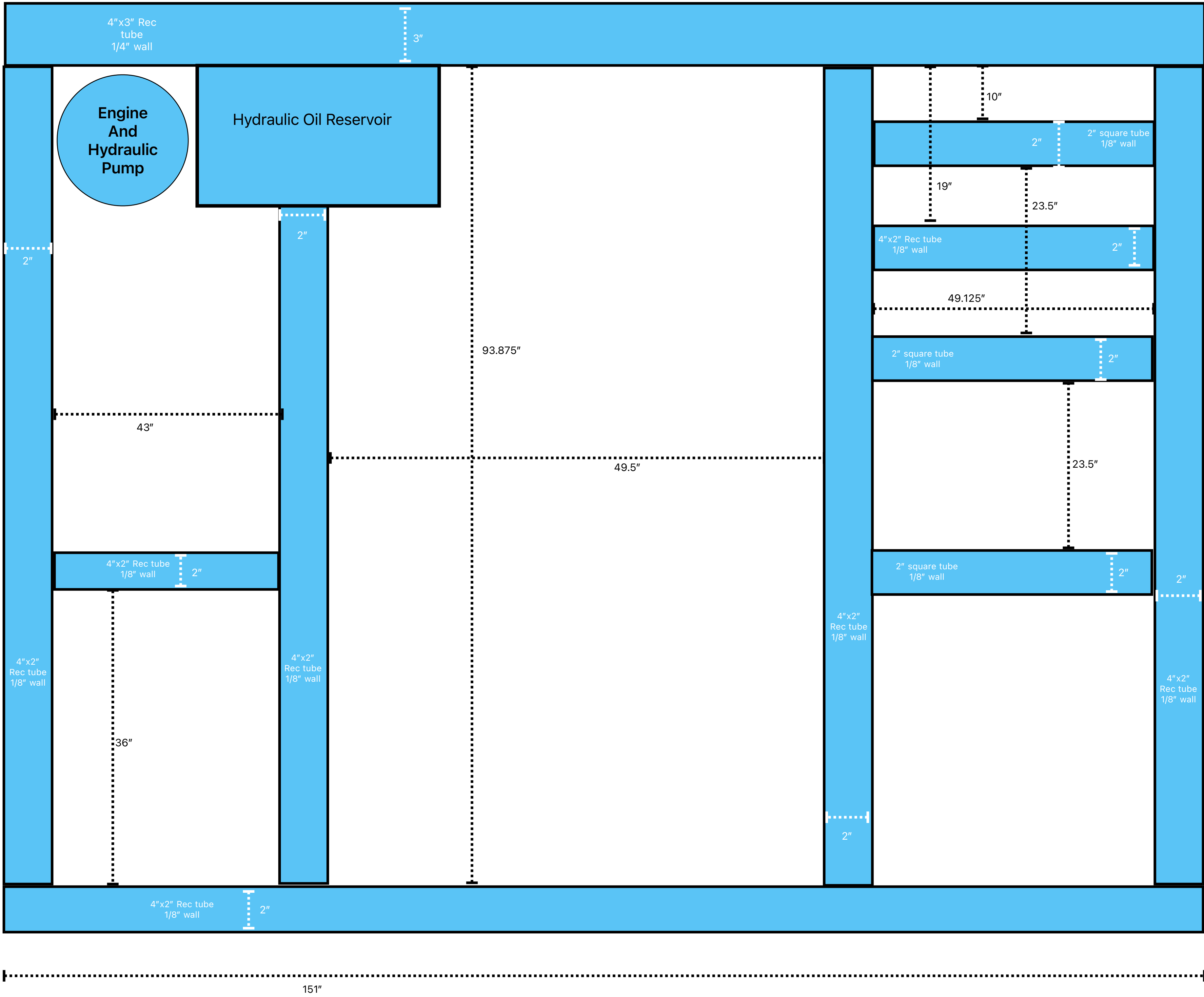

Right Pivot Axle

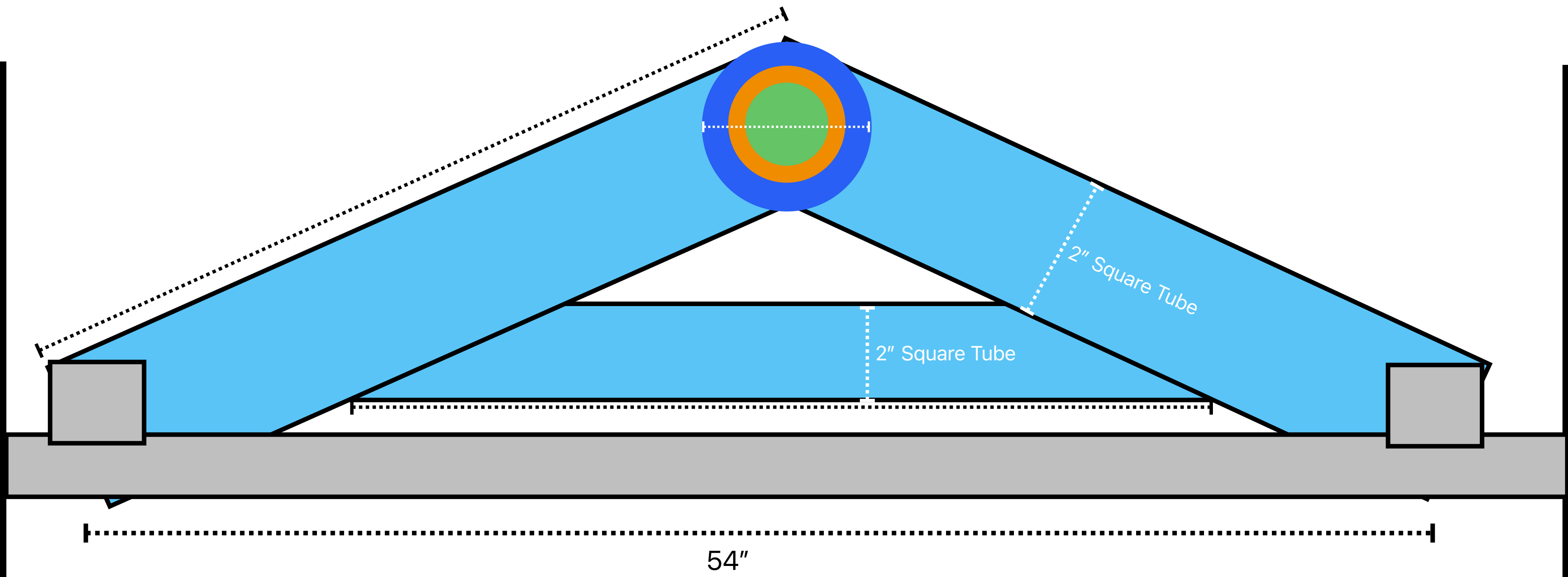

Picking Head Mount

Side View

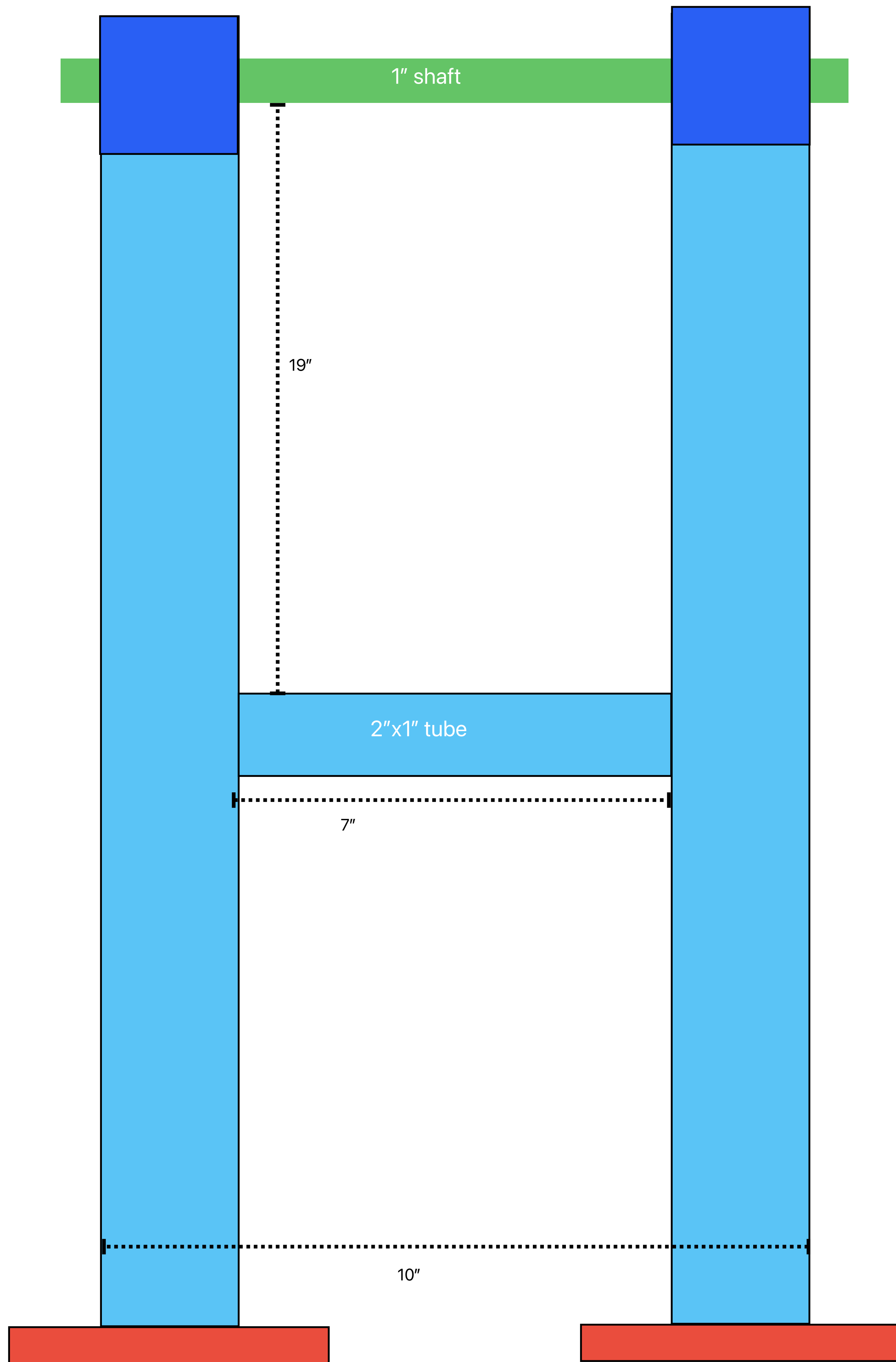

Top View

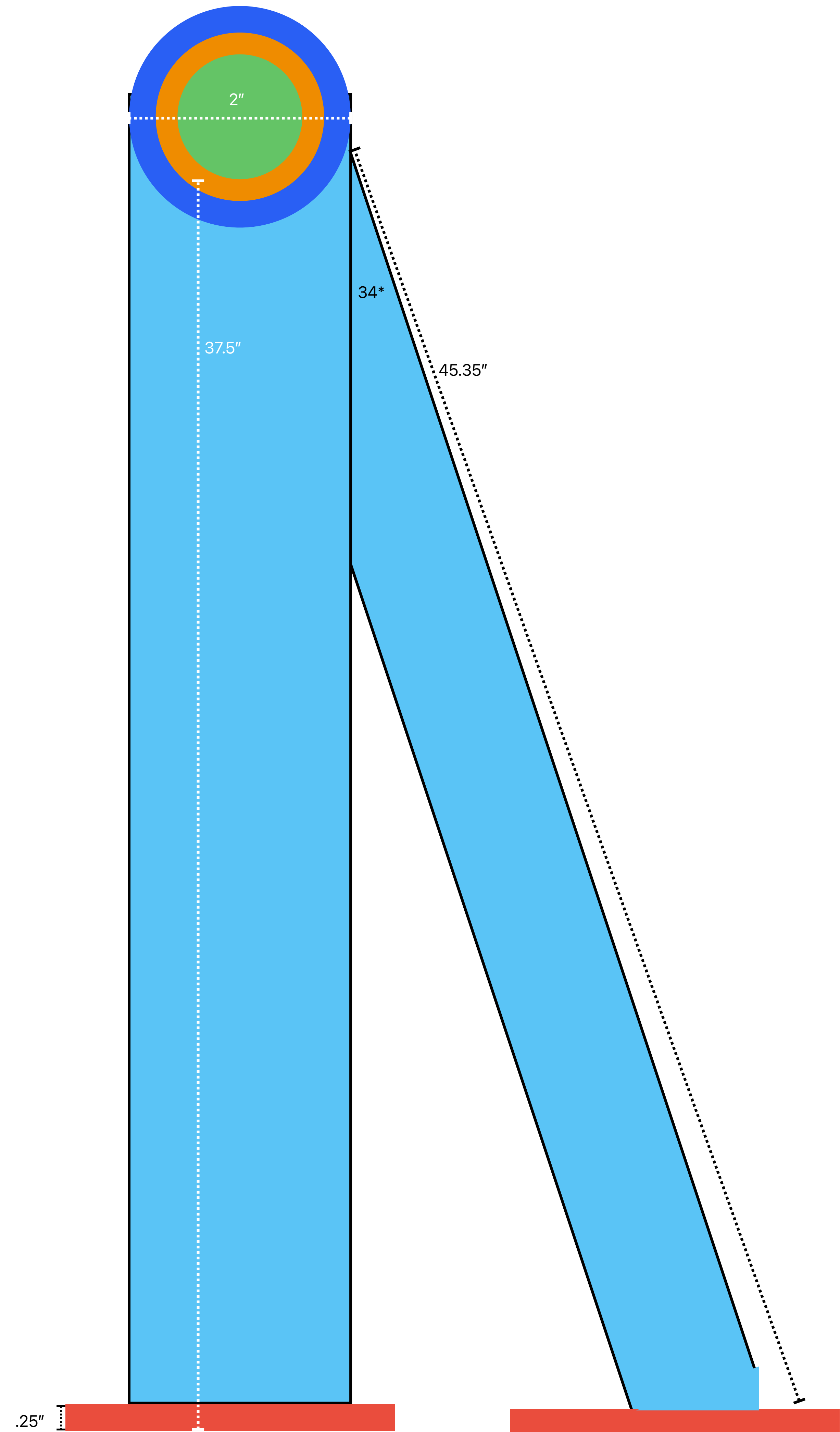

Picking Head Boom

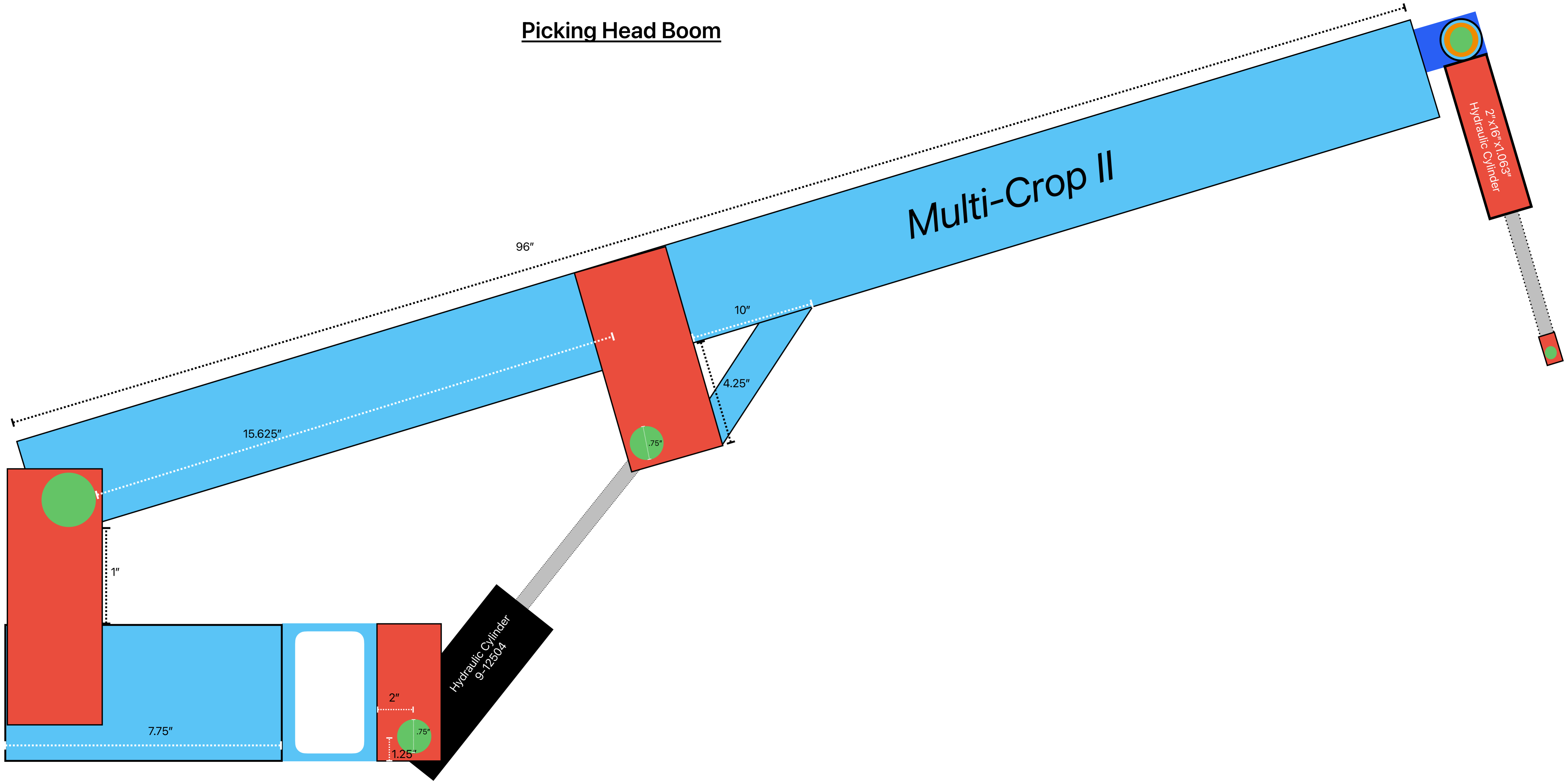

Side View

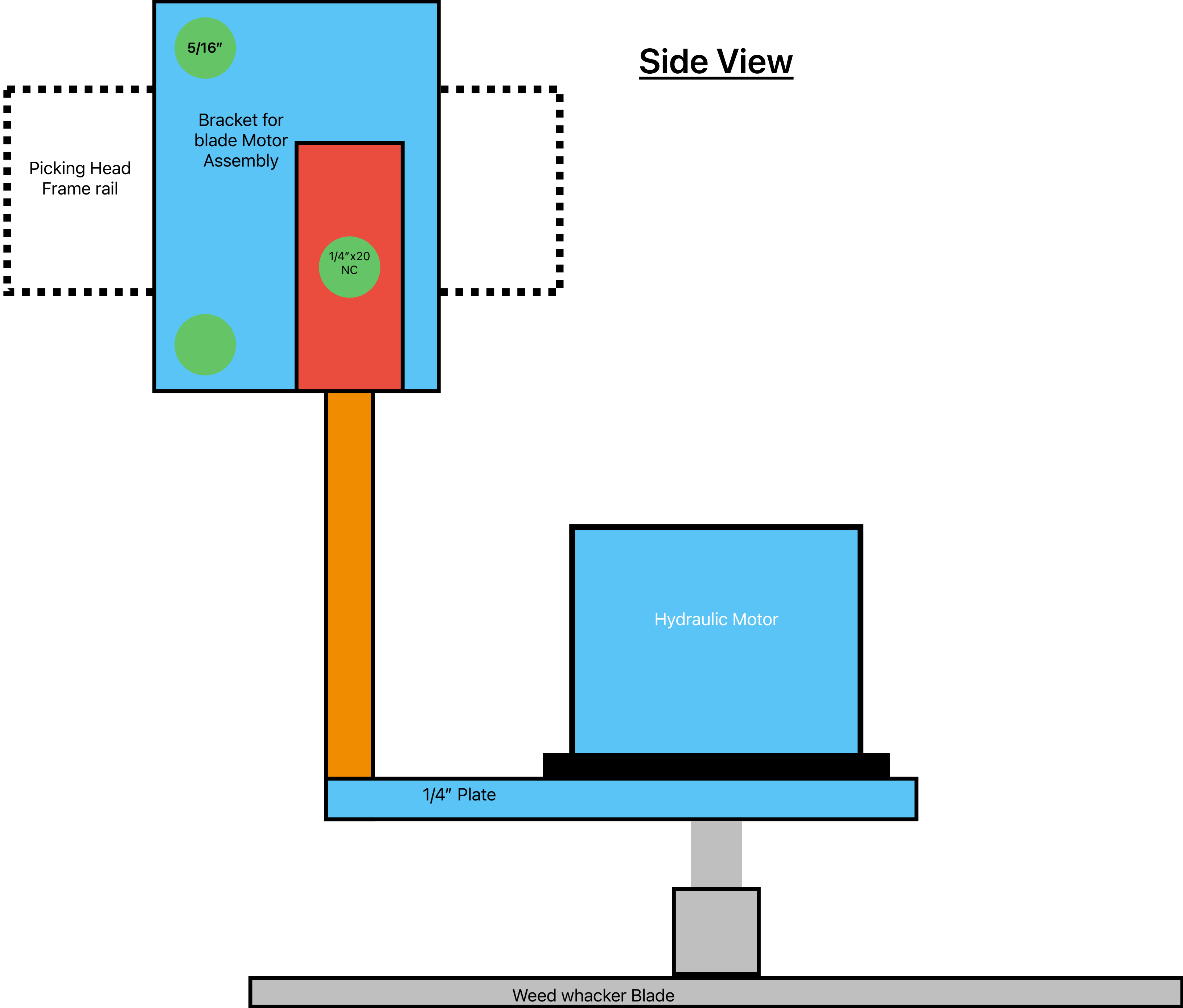

Top View

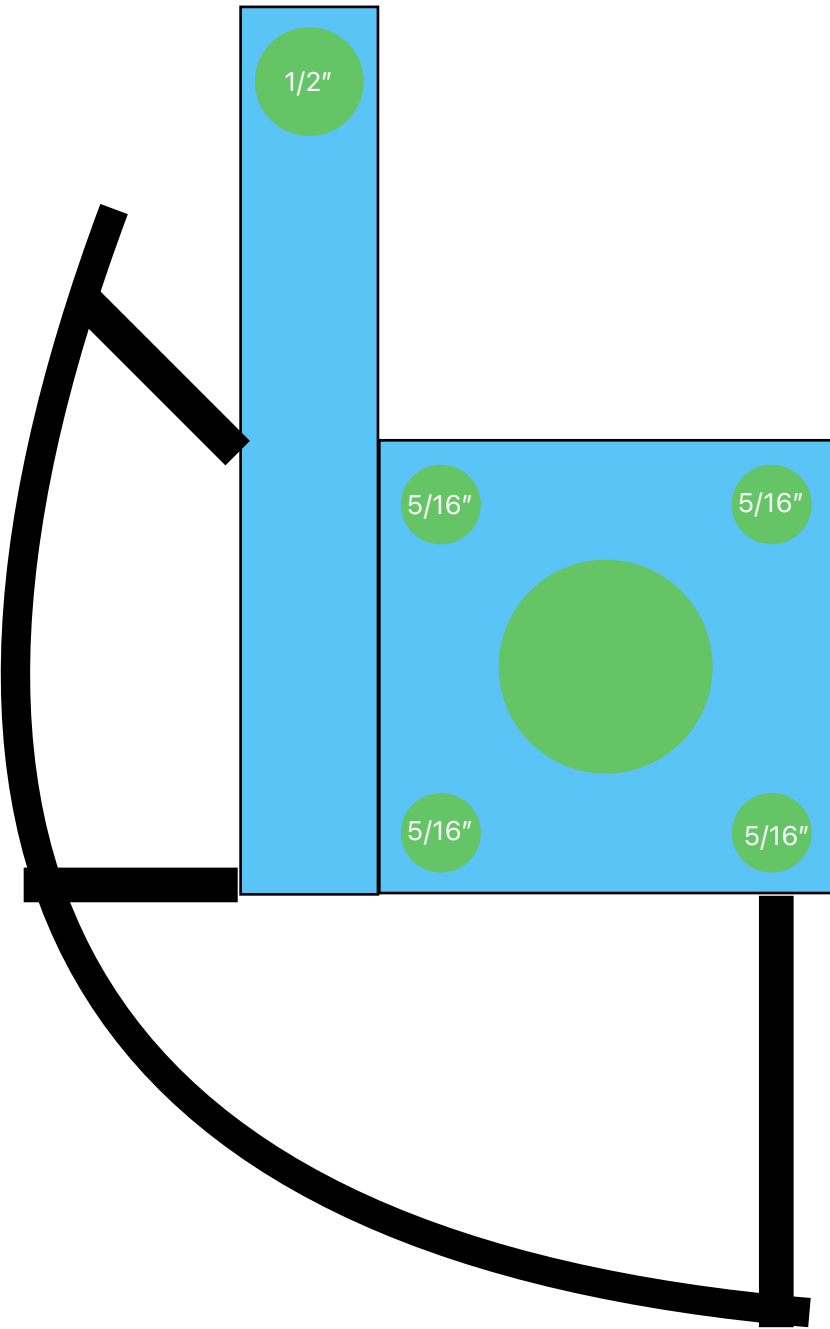

Drive Side

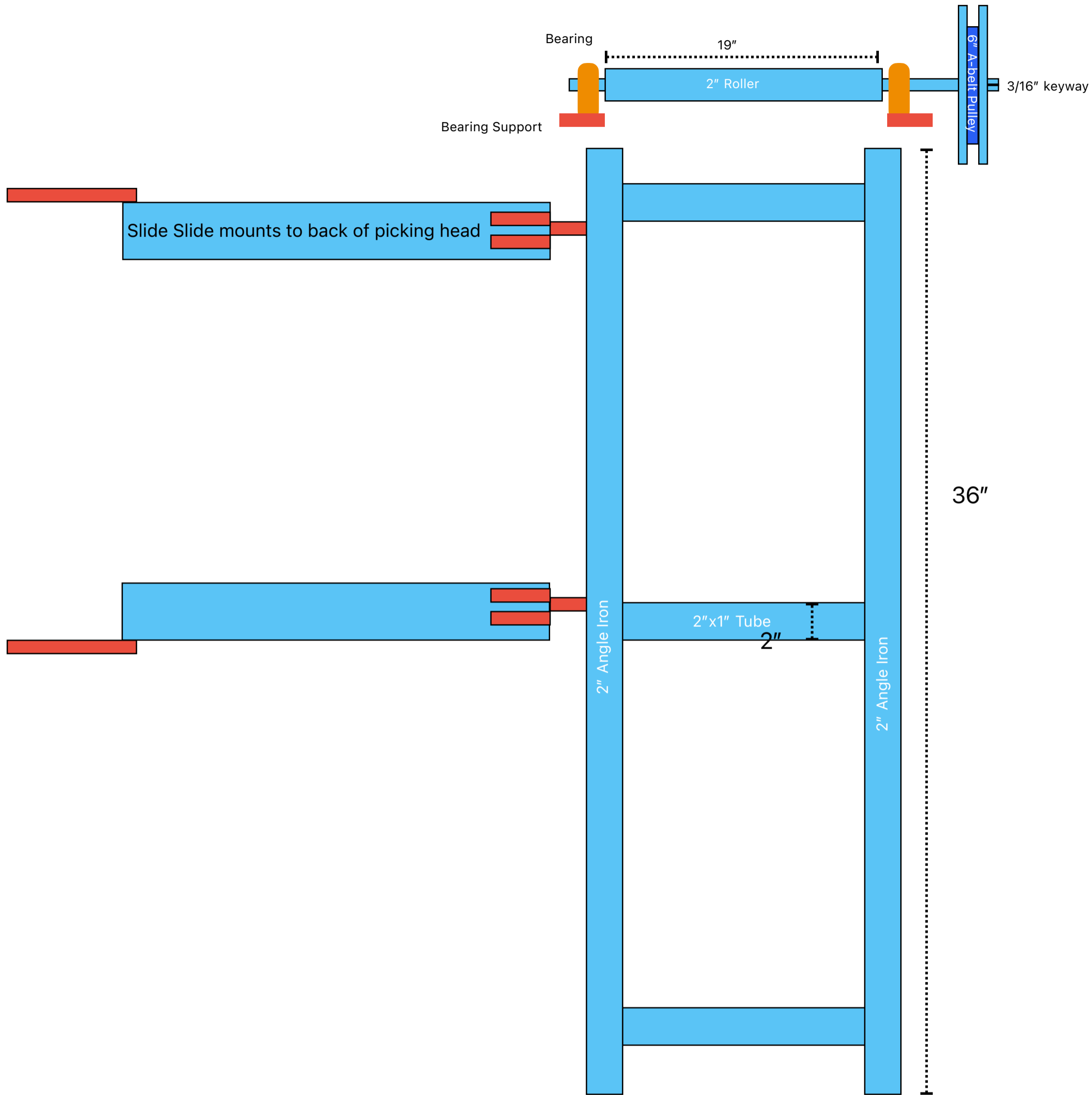

Motor Mount

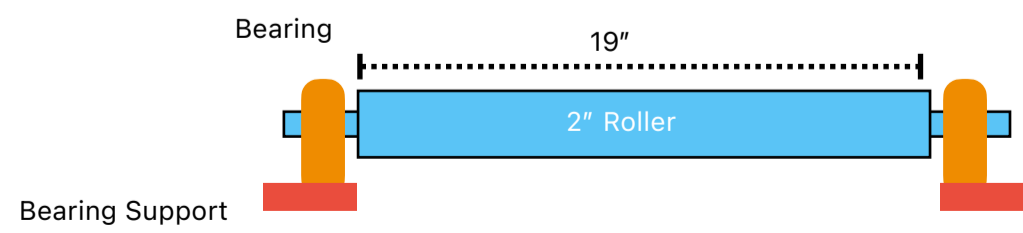
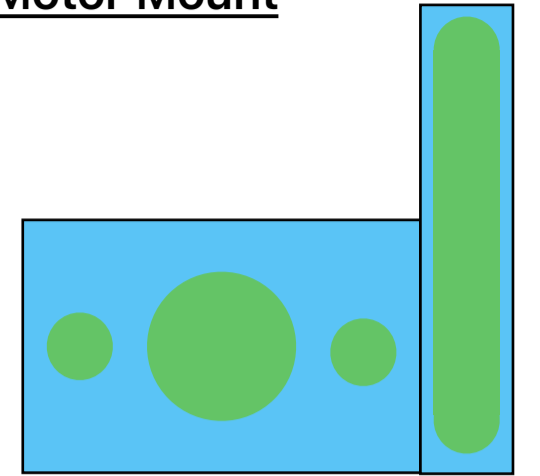

Idle/Tension Side

Basic Hydraulic system

